

ENGLISH



ENGLISH



ENGLISH



ENGLISH

Installation and User Manual

version 1.06

WDESK-R/L WINOX-R/L/2L WTAB-R/L

Load



CE 2004/108/EC

EN55022 EN61000-6-2 EN61000-6-4

SYSTEM IDENTIFICATION

KEY TO SYMBOLS

Below are the symbols used in the manual to draw the reader's attention:



Warning! Risk of electrocution.



Warning! This operation must be performed by skilled workers.



Read the following indications carefully.



Further information.

GUARANTEE

24 months from the delivery document date. The guarantee covers only defected parts and includes the replacement parts and labour. All shipping and packing costs are paid by the customer. It is possible to have the repair in guarantee on condition that the returned product has not been transformed, damaged or repaired without authorization. No guarantee is applicable on returned products without the original label and/or serial number. No guarantee against misuse.

Batteries: Laumas provides 1 year guarantee from the date of delivery note, against material defects or battery manufacturing faults.

Disposal of Waste Equipment by Users in Private Households in the European Union



This symbol on the product or on its packaging indicates that this product must not be disposed of with your other household waste. It is your responsibility to dispose of your waste equipment by handing it over to a designated collection point for the recycling of waste electrical and electronic equipment. The separate collection and recycling of your waste equipment at the time of disposal will help preserve natural resources and protect human health and the environment. For more information about where you can drop off your waste equipment for recycling, please contact your local waste disposal Authority or the equipment retailer.

TABLE OF CONTENTS

USER WARNINGS	1
RECOMMENDATIONS FOR CORRECT INSTALLATION OF WEIGHING INSTRUMENTS .	1
RECOMMENDATIONS FOR CORRECT INSTALLATION OF THE LOAD CELLS.....	1
LOAD CELL INPUT TEST (QUICK ACCESS)	3
LOAD CELL TESTING.....	3
MAIN SPECIFICATIONS OF THE INSTRUMENT	4
BUFFER BATTERY.....	6
AFTER A BLACKOUT	7
TECHNICAL SPECIFICATIONS	8
ELECTRICAL CONNECTIONS.....	9
BASIC INFORMATION.....	9
WIRING DIAGRAM.....	9
<i>CHANGING VOLTAGE 115VAC / 230VAC (WDESK).....</i>	<i>10</i>
<i>KEY TO P, Q, X TYPE CONNECTORS.....</i>	<i>10</i>
<i>KEY TO D TYPE CONNECTORS.....</i>	<i>11</i>
<i>KEY TO N TYPE CONNECTORS.....</i>	<i>12</i>
INTRODUCTION TO THE OPERATION	14
KEY, LED AND SYMBOLS FUNCTIONS	15
MENU MAP	18
SYSTEM PARAMETERS	18
BATCHING CONSTANTS.....	19
INSTRUMENT COMMISSIONING.....	20
PROGRAMMING OF SYSTEM PARAMETERS.....	21
THEORETICAL CALIBRATION.....	21
<i>TARE WEIGHT ZERO SETTING.....</i>	<i>22</i>
<i>ZERO VALUE MANUAL ENTRY.....</i>	<i>22</i>
REAL CALIBRATION (WITH SAMPLE WEIGHTS).....	22
FILTER ON THE WEIGHT	23
ZERO PARAMETERS.....	24
<i>RESETTABLE WEIGHT SETTING FOR SMALL WEIGHT CHANGES.....</i>	<i>24</i>
<i>AUTOMATIC ZERO SETTING AT POWER-ON</i>	<i>24</i>
<i>ZERO TRACKING.....</i>	<i>24</i>
SETTING UNITS OF MEASURE.....	25
OUTPUTS AND INPUTS CONFIGURATION	25
SEMI-AUTOMATIC TARE (NET/GROSS).....	26
PRESET TARE (SUBTRACTIVE TARE DEVICE).....	26
SEMI-AUTOMATIC ZERO (WEIGHT ZERO-SETTING FOR SMALL VARIATIONS)	27
ANALOG OUTPUT(ONLY FOR INSTRUMENTS WHERE THIS OPTION IS AVAILABLE) ..	28
SERIAL COMMUNICATION SETTING.....	30
<i>RS232 SERIAL COMMUNICATION.....</i>	<i>31</i>
<i>RS485 SERIAL COMMUNICATION.....</i>	<i>31</i>

<i>DIRECT CONNECTION BETWEEN RS485 AND RS232 WITHOUT CONVERTER</i>	31
ALARM RELAY CLOSURE	32
TEST	32
ENERGY SAVING	33
DATE AND TIME SETTING	33
OPERATION SETTINGS.....	34
INFO MENU	34
PROGRAMMING OF BATCHING CONSTANTS.....	35
MINIMUM WEIGHT.....	35
MAXIMUM WEIGHT	35
SAFE EMPTYING TIME	35
WAITING TIME.....	35
NO COMPARISON TIME	36
NO PRODUCT LOAD TIME	36
NO PRODUCT UNLOAD TIME.....	36
FALL.....	36
TOLERANCE.....	37
SLOW	37
TAPPING FUNCTION.....	37
AUTOTARE	38
AUTOTARE DELAY	38
STABLE TARE	38
CONSUMPTION FOR EACH FORMULA	38
PRINT AT CYCLE END.....	38
CHECKING PC PRESENCE	39
WAITING CONFIRMATION FROM PC (SLAVE)	39
SWITCHING OF THE ALARM RELAY ON WEIGHT	39
SWITCHING OF THE TOLERANCE RELAY ON WEIGHT.....	39
FORMULAS PROGRAMMING.....	40
DELETING FORMULAS.....	40
BATCHING	41
BATCHING START FROM EXTERNAL CONTACT	42
DISPLAYING DURING BATCHING.....	42
BATCHING STOP	43
RESUME BATCHING AFTER A POWER CUT	43
CONSUMPTION	44
CONSUMPTION DELETION	44
ALARMS.....	45
PRINTING EXAMPLES	47
RESERVED FOR THE INSTALLER	50
MENU LOCKING.....	50
MENU UNLOCKING.....	50

TEMPORARY MENU UNLOCKING.....	50
DATA DELETION AND PROGRAM SELECTION.....	50
KEYPAD OR DISPLAY LOCKING	51
DECLARATION OF CONFORMITY 	52

USER WARNINGS

RECOMMENDATIONS FOR THE PROPER USE OF WEIGHING INSTRUMENT

- Keep away from heat sources and direct sunlight
- Repair the instrument from rain (except special IP versions)
- Do not wash with water jets (except special IP versions)
- Do not dip in water
- Do not spill liquid on the instrument
- Do not use solvents to clean the instrument
- Do not install in areas subject to explosion hazard (except special Atex versions)

RECOMMENDATIONS FOR CORRECT INSTALLATION OF WEIGHING INSTRUMENTS

The terminals indicated on the instrument's wiring diagram to be connected to earth must have the same potential as the weighed structure (same earthing pit or earthing system). If you are unable to ensure this condition, connect with an earthing wire the terminals of the instrument (including the terminal – SUPPLY) to the weighed structure.

The cell cable must be individually led to its panel input and not share a conduit with other cables; connect it directly to the instrument terminal strip without breaking its route with support terminal strips.

Use "RC" filters on the instrument-driven solenoid valve and remote control switch coils.

Avoid inverters in the instrument panel; if inevitable, use special filters for the inverters and separate them with sheet metal partitions.

The panel installer must provide electric protections for the instruments (fuses, door lock switch etc.).

It is advisable to leave the equipment always switched on to prevent the formation of condensation.

MAXIMUM CABLE LENGTHS

- RS485: 1000 metres with AWG24, shielded and twisted cables
- RS232: 15 metres for baud rates up to 19200
- Analog current output: up to 500 metres with 0.5 mm² cable
- Analog voltage output: up to 300 metres with 0.5 mm² cable

RECOMMENDATIONS FOR CORRECT INSTALLATION OF THE LOAD CELLS

INSTALLING LOAD CELLS: The load cells must be placed on rigid, stable in-line structures; it is important to use the mounting modules for load cells to compensate for misalignment of the support surfaces.

PROTECTION OF THE CELL CABLE: Use water-proof sheaths and joints in order to protect the cables of the cells.

MECHANICAL RESTRAINTS (pipes, etc.): When pipes are present, we recommend the use of hoses and flexible couplings with open mouthpieces with rubber protection; in case of hard pipes, place the pipe support or anchor bracket as far as possible from the weighed structure (at a distance at least 40 times the diameter of the pipe).

CONNECTING SEVERAL CELLS IN PARALLEL: Connect several cells in parallel by using - if necessary - a watertight junction box with terminal box. The cell connection extension cables must be shielded, led individually into their piping or conduit and laid as far as possible from the power cables (in case of 4-wire connections, use cables with 4x1 mm² minimum cross-section).

WELDING: Avoid welding with the load cells already installed. If this cannot be avoided, place the welder ground clamp close to the required welding point to prevent sending current through the load cell body.

WINDY CONDITIONS - KNOCKS - VIBRATIONS: The use of weigh modules is strongly recommended for all load cells to compensate for misalignment of the support surfaces. The system designer must ensure that the plant is protected against lateral shifting and tipping relating to: shocks and vibration; windy conditions; seismic conditions in the installation setting; stability of the support structure.

EARTHING THE WEIGHED STRUCTURE: By means of a copper wire with suitable cross-section, connect the cell upper support plate with the lower support plate, then connect all the lower plates to a single earthing system. Electrostatic charges accumulated because of the product rubbing against the pipes and the weighed container walls are discharged to the ground without going through or damaging the load cells. Failure to implement a proper earthing system might not affect the operation of the weighing system; this, however, does not rule out the possibility that the cells and connected instrument may become damaged in the future. It is forbidden to ensure earthing system continuity by using metal parts contained in the weighed structure.

**FAILURE TO FOLLOW THE INSTALLATION RECOMMENDATIONS WILL BE CONSIDERED
A MISUSE OF THE EQUIPMENT**

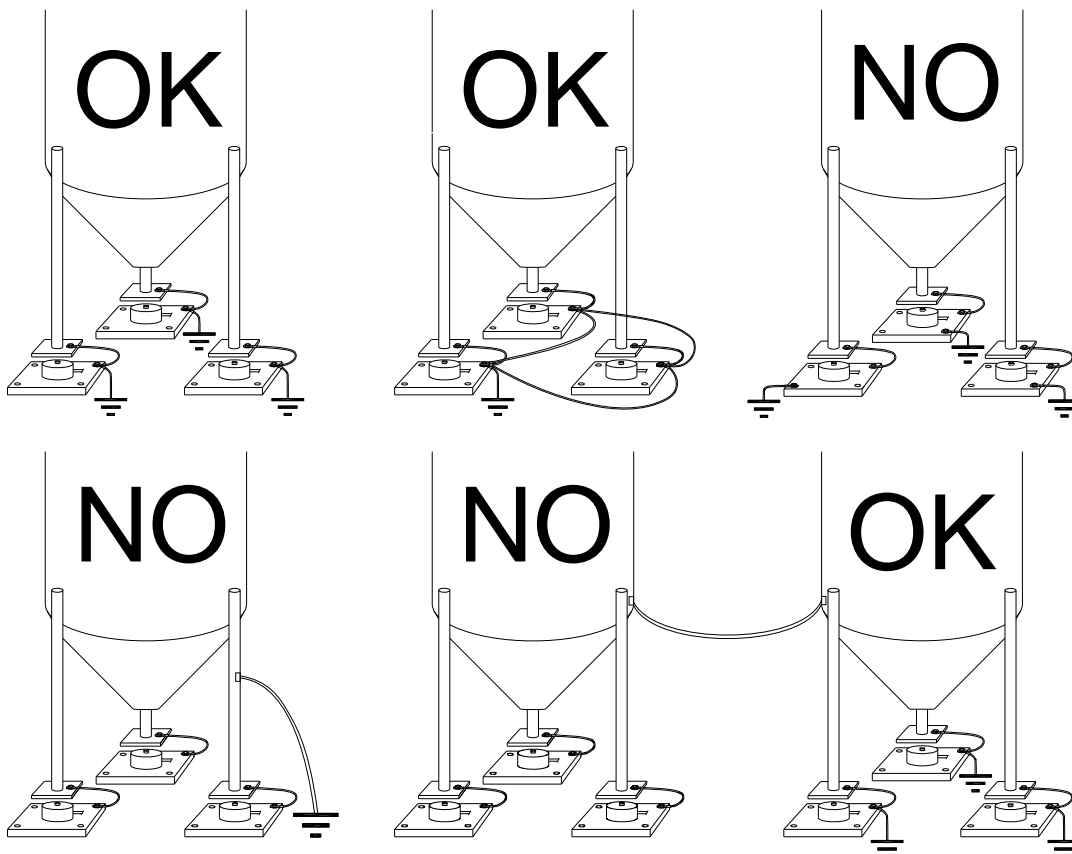

LOAD CELL INPUT TEST (QUICK ACCESS)

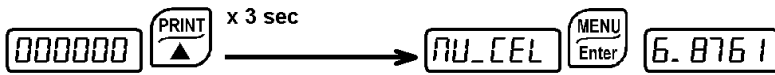

From the weight display, press  for 3 seconds; the response signal of the load cells is displayed, expressed in mV with four decimals.

LOAD CELL TESTING

Load cell resistance measurement (use a digital multimeter):

- Disconnect the load cells from the instrument and check that there is no moisture in the cell junction box caused by condensation or water infiltration. If so, drain the system or replace it if necessary.
- The value between the positive signal wire and the negative signal wire must be equal or similar to the one indicated in the load cell data sheet (output resistance).
- The value between the positive excitation wire and the negative excitation wire must be equal or similar to the one indicated in the load cell data sheet (input resistance).
- The insulation value between the shield and any other cell wire and between any other cell wire and the body of the load cell must be higher than 20 Mohm.

Load cell voltage measurement (use a digital multimeter):

- Take out the load cell to be tested from underneath the container, or alternatively, lift the container support.
- Make sure that the excitation of two wires of the load cell connected to the instrument (or amplifier) is 5 Vdc \pm 3%.
- Measure the response signal between the positive and the negative signal wires by directly connecting them to the tester, and make sure that it is comprised between 0 and 0.5 mV.
- Apply load to the cell and make sure that there is a signal increment.

IF ONE OF THE ABOVE CONDITIONS IS NOT MET, PLEASE CONTACT THE TECHNICAL ASSISTANCE SERVICE.

MAIN SPECIFICATIONS OF THE INSTRUMENT

Indicator with 6-wire load cell input installable on table, panel front, wall or column; 6-key membrane keypad (WTAB: 8-key) with buzzer, real-time clock/calendar with buffer battery.



Two serial ports (RS485 and RS232) for connection to: PC/PLC up to 32 instruments (max 99 with line repeaters) by ASCII Laumas or ModBus R.T.U. protocol, remote display, printer. Optional: integrated Profibus DP, DeviceNet, CANopen, Profinet IO, Ethernet/IP, Ethernet TCP/IP, Modbus/TCP output.





Instruments with P, D, N type connectors: included switching power supply plug 24 V 450 mA, input 100÷240 VAC, 3 meters long cable.





Display:



Model	Display	Digit height	LED or signalling symbols
WDESK-R WINOX-R WTAB-R	Red LED, 6 digits, 7 segments, semi-alphanumeric	20 mm	16
WDESK-L WINOX-L WTAB-L	Backlit LCD, 6 digits, 7 segments, semi-alphanumeric	20 mm	max 46
WINOX-2L	Large backlit LCD, 6 digits, 7 segments, semi-alphanumeric	40 mm	max 46

Dimensions:

WDESK	Version	Max. encumbrance	Drilling
	P - PG9 cable gland IP67 protection rating Power supply included	122x226x164 mm (connectors included)	96x186 mm
	Q - Removable terminal strip (panel front) Front panel IP67 protection rating	122x226x152 mm (connectors included)	92x186 mm
	D - D-Sub tray IP40 protection rating Power supply included	122x226x189 mm (connectors included)	96x186 mm

	<p>N – IP65 circular connectors</p> <p>IP65 protection rating</p> <p>Power supply included</p>	122x226x218 mm (connectors included)	96x186 mm
	<p>X - Atex cable gland</p> <p>IP67 Atex  II3GD version (areas 2 -22)</p> <p>IP67 protection rating</p>	122x226x164 mm (connectors included)	96x186 mm
	Wall installation with bracket (can also be installed on table)	122x230x250 mm ca. (bracket included)	

WINOX	Type of connectors	Max. encumbrance	Drilling
	<p>P - PG9 cable gland</p> <p>IP68 protection rating</p> <p>Power supply included</p>	206x286x108 mm (connectors included)	160x248 mm
	<p>Q - Removable terminal strip (panel front)</p> <p>Front panel IP68 protection rating</p>	206x286x96 mm (connectors included)	160x248 mm
	<p>D – D-Sub tray (table)</p> <p>IP40 protection rating</p> <p>Power supply included</p>	206x286x85 mm (connectors included)	
	<p>N – IP65 circular connectors</p> <p>IP65 protection rating</p> <p>Power supply included</p>	206x286x160 mm (connectors included)	160x248 mm

	<p>X - Atex cable gland IP68 Atex  II3GD version (areas 2 -22) IP68 protection rating</p>	206x286x108 mm (connectors included)	160x248 mm
	Wall installation with bracket (can also be installed on table)	206x286x187 mm ca. (bracket included)	

WTAB	Type of connectors	Max. encumbrance	Drilling
	<p>D – D-Sub tray IP40 protection rating Power supply included</p>	315X315X180 mm	

BUFFER BATTERY

The instrument is equipped with an internal battery that allows to keep active the internal clock even in the event of power failure.



At the first start and after long periods of inactivity, leave the instrument on for at least 12 hours to fully charge the battery.

AFTER A BLACKOUT

After a blackout the instrument DOES NOT come on again automatically, you have to press **ON**.
To guarantee an automatic restart after a blackout, disable the ON key as follows:

- disconnect power supply and open the instrument;
- identify flat connectors coming from the keypad on the main board;
- extract the 4-pole connector;
- short-circuit the following pins using the unused jumper inside the instrument:
 - WDESK: the two pins further in compared to the main board (see picture to the left);
 - WINOX - WTAB: the two outer pins compared to the main board (see picture to the right);
- connect the 4-pole flat to the two pins still free complying with initial orientation.

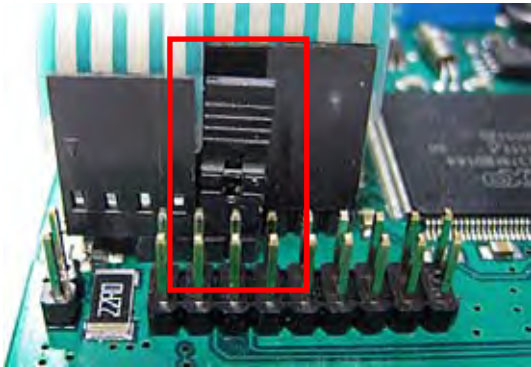

TECHNICAL SPECIFICATIONS

POWER SUPPLY and CONSUMPTION (VDC)	12/24 VDC $\pm 10\%$; 6 W (standard)
POWER SUPPLY and CONSUMPTION (VAC)	115/230 VAC; 50-60 Hz; 6 VA (optional only for WDESK)
NO. OF LOAD CELLS IN PARALLEL and SUPPLY	max 8 (350 ohm); 5 VDC / 120 mA
LINEARITY / ANALOG OUTPUT LINEARITY	$< 0.01\%$ F.S.; $< 0.01\%$ F.S.
THERMAL DRIFT / ANALOG OUTPUT THERMAL DRIFT	$< 0.0005\%$ F.S./ $^{\circ}\text{C}$; $< 0.003\%$ F.S./ $^{\circ}\text{C}$
A/D CONVERTER	24 bit (16000000 points)
MAX DIVISIONS (with measurement range: ± 10 mV = sens. 2 mV/V)	± 999999
MEASUREMENT RANGE	± 39 mV
MAX SENSITIVITY OF USABLE LOAD CELLS	± 7 mV/V
MAX CONVERSIONS PER SECOND	300 conversions/second
DISPLAY RANGE	± 999999
NO. OF DECIMALS / DISPLAY INCREMENTS	0÷4 / x 1 x 2 x 5 x 10 x 20 x 50 x 100
DIGITAL FILTER / READINGS PER SECOND	0.012÷7 s / 5÷300 Hz
RELAY LOGIC OUTPUTS	N.5 - max 115 VAC; 150 mA (N. 4 – analog output version)
LOGIC INPUTS	N.3 - optoisolated 5 - 24 VDC PNP (N. 2 – analog output version)
SERIAL PORTS	RS485, RS232
BAUD RATE	2400, 4800, 9600, 19200, 38400, 115200
HUMIDITY (non condensing)	85%
STORAGE TEMPERATURE	-30 $^{\circ}\text{C}$ +80 $^{\circ}\text{C}$
WORKING TEMPERATURE	-20 $^{\circ}\text{C}$ +60 $^{\circ}\text{C}$
OPTOISOLATED ANALOG OUTPUT (OPTIONAL) 16 bit - 65535 divisions	0÷20 mA; 4÷20 mA (max 300 ohm); 0÷10 V; 0÷5 V; ± 10 V; ± 5 V (min 10 kohm)

ELECTRICAL CONNECTIONS

BASIC INFORMATION

- It is recommended that the power supply negative pole be grounded (WDESK-D, WINOX, WTAB: connect the earthing system to the dedicated external terminal \perp).
- It is possible to supply up to eight 350 ohm load cells or sixteen 700 ohm load cells.
- For 4-wire load cells, make a jumper between EX- and REF- and between EX+ and REF+.
- Connect terminal “- SUPPLY” to the RS485 common of the connected instruments in the event that these receive alternating current input or that they have an optoisolated RS485.
- In case of an RS485 network with several devices it is recommended to activate the 120 ohm termination resistance on the two devices located at the ends of the network, as described in section **RS485 SERIAL CONNECTION**.
- Option **E/EC**: selects the first 12 formulas.

WIRING DIAGRAM

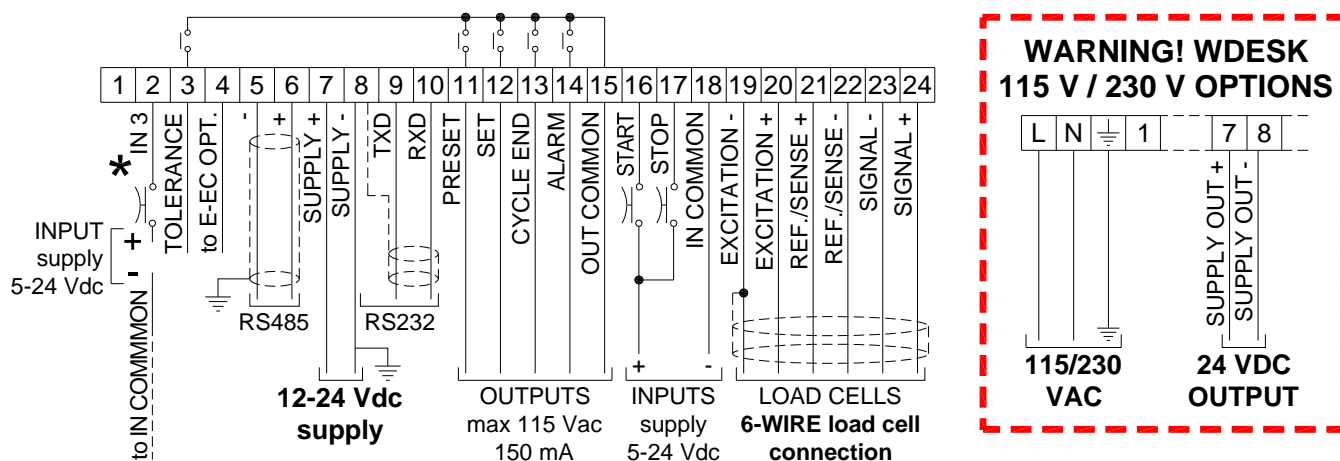

(1) ANALOG OUTPUT OPTION

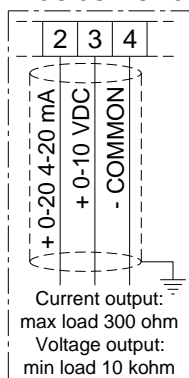

4-WIRE load cell connection

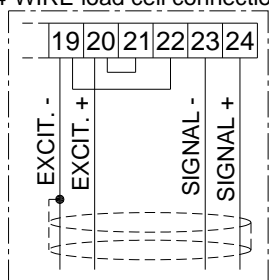

E OPTION

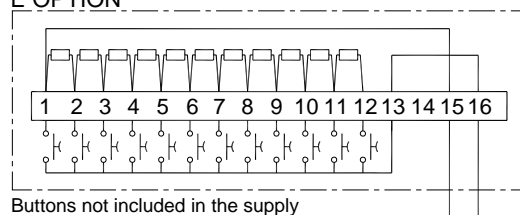

EC OPTION

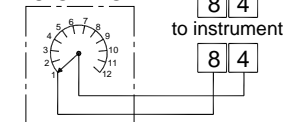

- ★) The **IN3** input can have the following functions:
- **APPROVAL**
 - **SEMI-AUTOMATIC ZERO** (default)
 - **NET/GROSS WEIGHT**

- (1) If the analog output is present (ANALOG OUTPUT OPTION) the following are no longer available:
- **IN3** input
 - **TOLERANCE** output
 - **E/EC** options

WARNING: connect power supply specified on the plate found on the back of the instrument. In 115 V and 230 V versions, terminals “+ SUPPLY” and “- SUPPLY” generate continuous voltage at 24 Vdc only to be used as power supply for instrument inputs.

CHANGING VOLTAGE 115VAC / 230VAC (WDESK)

Access instrument board by removing the six bottom screws and work on the welding side: join the red points using a stiff wire.

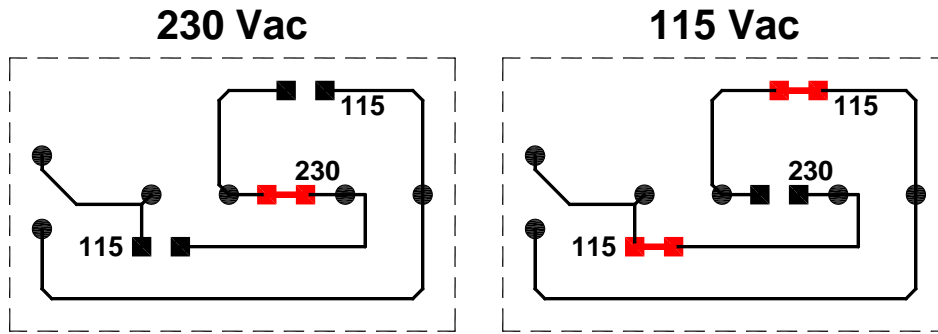

KEY TO P, Q, X TYPE CONNECTORS

Terminal	Signal	Terminal	Signal
1		14	OUTPUT No. 4: ALARM
2	INPUT No. 3: selectable (+VDC min 5 V max 24 V) <i>otherwise:</i> +ANALOG OUTPUT (0÷20 o 4÷20 mA)	15	OUTPUT COMMON
3	OUTPUT No. 5: TOLERANCE <i>otherwise:</i> +ANALOG OUTPUT (0÷10 V)	16	INPUT No. 1: START (+VDC min 5 V max 24 V)
4	E/EC OPTION <i>otherwise:</i> -ANALOG OUTPUT COMMON	17	INPUT No. 2: STOP (+VDC min 5 V max 24 V)
5	RS485: -	18	INPUT COMMON (-VDC 0 V)
6	RS485: +	19	-LOAD CELL EXCITATION (-Exc) LOAD CELL SHIELD
7	+SUPPLY (12/24 VDC) 115/230 VAC optional version: +OUTPUT (24 VDC)	20	+LOAD CELL EXCITATION (+Exc)
8	-SUPPLY (12/24 VDC) RS232, RS485: SHIELD, GND E/EC OPTION: GND 115/230 VAC optional version: -OUTPUT (24 VDC) RS232, RS485: SHIELD, GND E/EC OPTION: GND	21	+LOAD CELL REF/SENSE
9	RS232: TXD	22	-LOAD CELL REF/SENSE
10	RS232: RXD	23	-LOAD CELL SIGNAL (-Sig)

11	OUTPUT No. 1: PRESET	24	+LOAD CELL SIGNAL (+Sig)
12	OUTPUT No. 2: SET	L	PHASE (115/230 VAC optional ver.)
13	OUTPUT No. 3: CYCLE END	N	NEUTRAL (115/230 VAC optional ver.)
		\perp	GROUND (115/230 VAC optional ver.)



To access the terminal strip on the WDESK instruments with cable glands, you need to remove the bottom of the instrument unscrewing the six screws.



KEY TO D TYPE CONNECTORS

Connector	Pin	Signal	Internal terminal	Internal colour
P1 Power supply		+SUPPLY (12/24 VDC)	7	red
		-SUPPLY (12/24 VDC)	8	black
D1 Female Load cell	1	-LOAD CELL EXCITATION (-Exc)	19	black
	2	-LOAD CELL REF/SENSE	22	yellow
	3			
	4			
	5	LOAD CELL SHIELD	19	
	6	+LOAD CELL EXCITATION (+Exc)	20	red
	7	+LOAD CELL REF/SENSE	21	blue
	8	-LOAD CELL SIGNAL (-Sig)	23	white
	9	+LOAD CELL SIGNAL (+Sig)	24	green
D3 Male I/O Analog output E/EC option	1	OUTPUT No.1: PRESET (max 24 V)	11	yellow
	2	OUTPUT No.2: SET (max 24 V)	12	blue
	3	OUTPUT No.3: CYCLE END (max 24 V)	13	white
	4	OUTPUT No.4: ALARM (max 24 V)	14	green
	5	OUTPUT No. 5: TOLERANCE (max 24 V) <i>otherwise:</i> +ANALOG OUTPUT (0÷10 V)	3	orange
	6	OUTPUT COMMON (max 24 V)	15	purple
	7	INPUT No.1: START (+VDC min 5 V max 24 V)	16	grey
	8	INPUT No.2: STOP (+VDC min 5 V max 24 V)	17	pink
	9	INPUT No. 3: selectable (+VDC min 5 V max 24 V) <i>otherwise:</i> +ANALOG OUTPUT (0÷20 o 4÷20 mA)	2	brown
	10	INPUT COMMON (-VDC 0 V)	18	white/blue
	11	E/EC OPTION <i>otherwise:</i> -ANALOG OUTPUT COMMON	4	red
	12	E/EC OPTION: GND ANALOG OUTPUT: SHIELD	8	black

	13			
	14			
	15			
D4 Male RS232 serial port	1			
	2	RS232: RXD	10	yellow
	3	RS232: TXD	9	blue
	4			
	5	RS232: SHIELD, GND	8	black
	6			
	7			
	8			
D5 Male RS485 serial port	1			
	2			
	3			
	4	RS485: +	6	yellow
	5	RS485: SHIELD, GND	8	black
	6	RS485: -	5	blue
	7	RS485: -	5	blue
	8			
	9	RS485: +	6	yellow

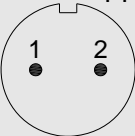
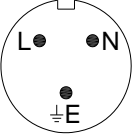
KEY TO N TYPE CONNECTORS

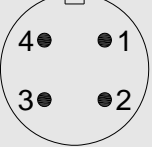
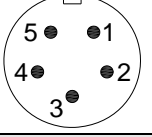
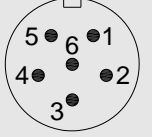
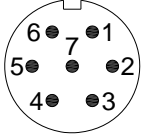
Connector	Pin	Signal	Internal terminal	Internal colour
C2 Standard version 12/24 VDC: Power supply 	1	+SUPPLY (12/24 VDC)	7	red
	2	-SUPPLY (12/24 VDC)	8	black
C3 Optional version 115/230 VAC: Power supply 	L	PHASE	L	brown
	\perp	GROUND	\perp , 8	yellow/ green
	N	NEUTRAL	N	blue

<p>C4</p> <p>IN3/OUT 5 <i>otherwise:</i> Analog output</p> 	1	OUTPUT No.5: TOLERANCE (max 24 V) <i>otherwise:</i> +ANALOG OUTPUT (0÷20 o 4÷20 mA)	3 ----- 2	yellow
	2	OUTPUT COMMON (max 24 V) <i>otherwise:</i> -ANALOG OUTPUT COMMON (0÷10 V)	15 ----- 3	blue
	3	INPUT No.3: selectable (+VDC min 5 V max 24 V) <i>otherwise:</i> -ANALOG OUTPUT COMMON	2 ----- 4	white
	4	INPUT COMMON (-VDC 0 V) <i>otherwise:</i> ANALOG OUTPUT: SHIELD	18 ----- 8	green
<p>C5</p> <p>RS232 and RS485 serial ports</p> 	1	RS485/RS232: SHIELD, GND	8	black
	2	RS485: -	5	yellow
	3	RS485: +	6	blue
	4	RS232: RXD	10	white
	5	RS232: TXD	9	green
<p>C6</p> <p>E/EC option Output 24 VDC</p> 	1			
	2			
	3			
	4	E/EC OPTION	4	yellow
	5	115/230 VAC optional version: -OUTPUT (24 VDC) E/EC OPTION: GND	8	black
	6	+OUTPUT (24 VDC) (115/230 VAC optional version)	7	red
<p>C7</p> <p>Load cell</p> 	1	+LOAD CELL EXCITATION (+Exc)	20	red
	2	-LOAD CELL EXCITATION (-Exc)	19	black
	3	+LOAD CELL REF/SENSE	21	blue
	4	LOAD CELL SHIELD	19	
	5	+LOAD CELL SIGNAL (+Sig)	24	green
	6	-LOAD CELL SIGNAL (-Sig)	23	white
	7	-LOAD CELL REF/SENSE	22	yellow
<p>C9</p> <p>IN/OUT</p> 	1	OUTPUT No.1: PRESET (max 24 V)	11	yellow
	2	OUTPUT No.2: SET (max 24 V)	12	blue
	3	OUTPUT No.3: CYCLE END (max 24 V)	13	white
	4	OUTPUT No.4: ALARM (max 24 V)	14	green
	5	OUTPUT COMMON (max 24 V)	15	orange
	6	INPUT No.1: START (+VDC min 5 V max 24 V)	16	purple
	7	INPUT No.2: STOP (+VDC min 5 V max 24 V)	17	grey
	8	INPUT COMMON (-VDC 0 V)	18	pink
	9			

INTRODUCTION TO THE OPERATION

The instrument is able to load automatically a settable amount of product on the weighing structure, driving the batching organ (including two-speed) through the PRESET and SET contacts.

The instrument has the following features:

- Maximum 99 settable formulas (see section **FORMULAS PROGRAMMING**);
- Batching resume after blackout (see section **RESUME BATCHING AFTER A POWER CUT**);
- Automatic fall calculation (see section **FALL**);
- Autotare at batching start (see section **AUTOTARE**);
- Tolerance error control (see section **TOLERANCE**);
- Precision batching through slow function (see section **SLOW**);
- Precision batching through tapping function (see section **TAPPING FUNCTION**);
- Consumption storage (see section **CONSUMPTION**);
- Print of batching data (see section **PRINT AT CYCLE END**);
- Alarm contact (see section **ALARM RELAY CLOSURE**);

BATCHING START:

- via keypad, setting formula and cycle number to be performed;
- via external contact (see section **BATCHING START FROM EXTERNAL CONTACT**).

For further information on the batching sequence, see section **BATCHING**.

CONSUMPTION STORAGE:

The instrument, at the end of every batching, stores the consumed amount for each formula. Consumption value can be viewed directly on instrument display in standby mode.

INSTRUMENT CALIBRATION:

The instrument calibration can be performed both with **THEORETICAL CALIBRATION**, setting the instrument full scale and the load cells sensitivity (see section **THEORETICAL CALIBRATION**), and with **REAL CALIBRATION** through **SAMPLE WEIGHT** (see section **REAL CALIBRATION (WITH SAMPLE WEIGHTS)**).













ALARM MANAGEMENT:

If an alarm occurs during the batching, the instrument shows the alarm on the display, closes the related contact (if enable) and waits for operator intervention to abort or continue the batching.

KEY, LED AND SYMBOLS FUNCTIONS

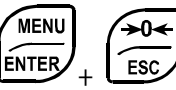
KEYS

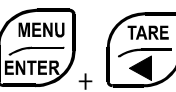
WARNING: MODE and PTARE keys are only available in WTAB instruments.

KEY	Short press	Long press (3 s)	Into menus
	Power-on	Power-off	
	Semi-automatic zero	Tare resetting	Cancel or return to previous menu
	Gross → Net	Net → Gross	Select figure to be modified or go to previous menu item.
	Batching start / stop		
			
	Setting up to 9 preset tares	Disable the applied preset tare	
	Print menu	mV load cell test	Modify selected figure or go to next menu item.
	Setting formulas and batching constants	Formula selection for START input (EC not present)	Confirm or enter in submenu
	Setting general parameters (press  immediately followed by )		
	Setting preset tare (press  immediately followed by )		

LED: WDESK-R, WINOX-R, WTAB-R

LED	Function
POWER	power supply available
NET	net weight (semi-automatic tare or preset tare)
→0←	zero (deviation from zero not more than ± 0.25 divisions)
▾	stability
kg	unit of measure: kg
g	unit of measure: g
W1	not used
W2	
W3	
INPUT 1	LED lit: input 1 closed
INPUT 2	LED lit: input 2 closed
INPUT 3	LED lit: input 3 closed
P1	LED lit: output 1 closed
P2	LED lit: output 2 closed
P4	LED lit: output 3 closed
P8	LED lit: output 4 closed
R5	LED lit: output 5 closed



Into menus LEDs light up in sequence to indicate that it is not displaying a weight.

SYMBOLS: WDESK-L, WINOX-L, WINOX-2L, WTAB-L

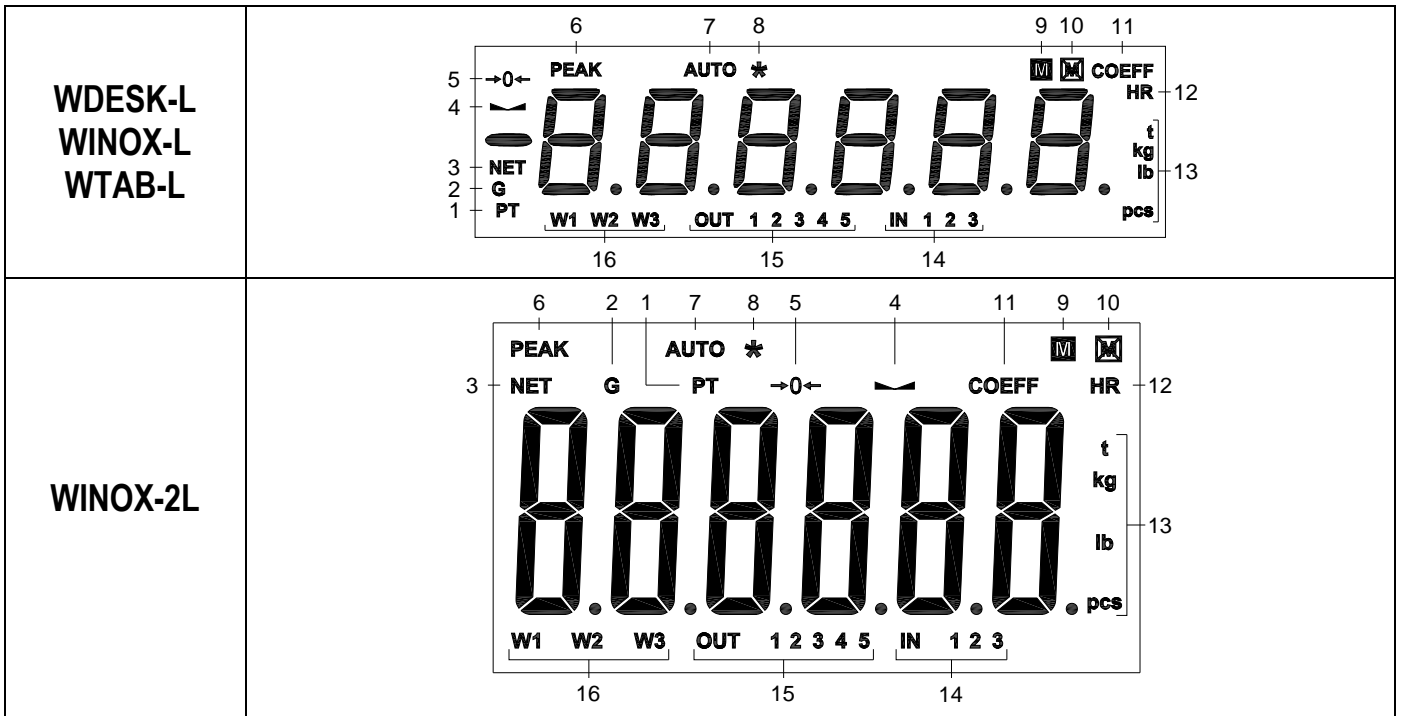

Symbol	Function
LED POWER	power supply available
1	preset tare enabled
2	gross weight
3	net weight (semi-automatic tare or preset tare)
4	stability
5	zero (deviation from zero not more than +/-0.25 divisions)
6	not used
7	batching in progress
8	value displayed is not a weight
9	not used
10	not used
11	not used
12	not used
13	unit of measure reading
14	the number displayed indicates that the corresponding input is closed
15	the number displayed indicates that the corresponding output is closed
16	not used



Into menus symbol 8 is on to indicate that it is not displaying a weight.

MENU MAP

Into menus changes are applied right after pressing the **ENTER** key (no further confirmation is required).

SYSTEM PARAMETERS

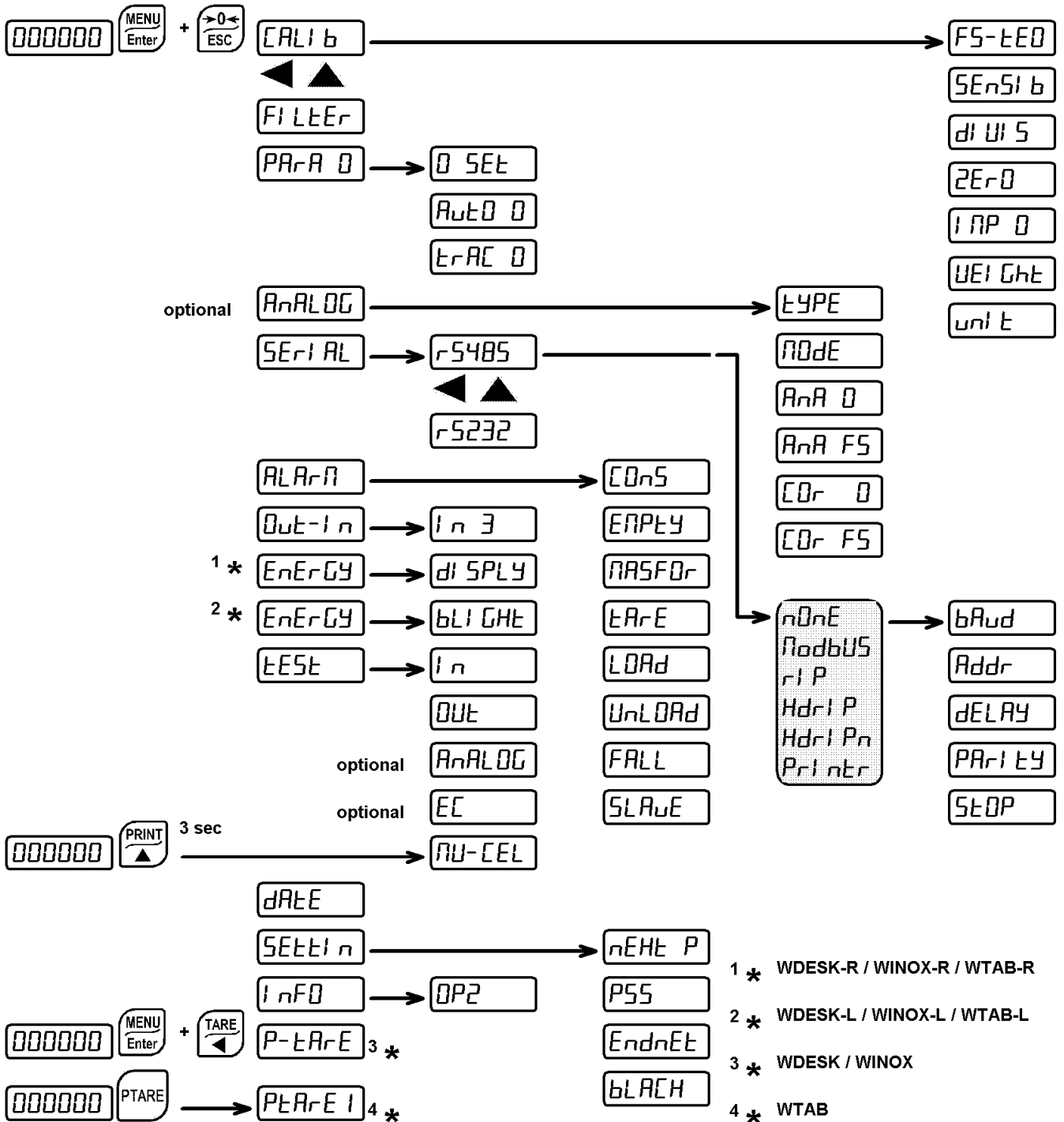

BATCHING CONSTANTS

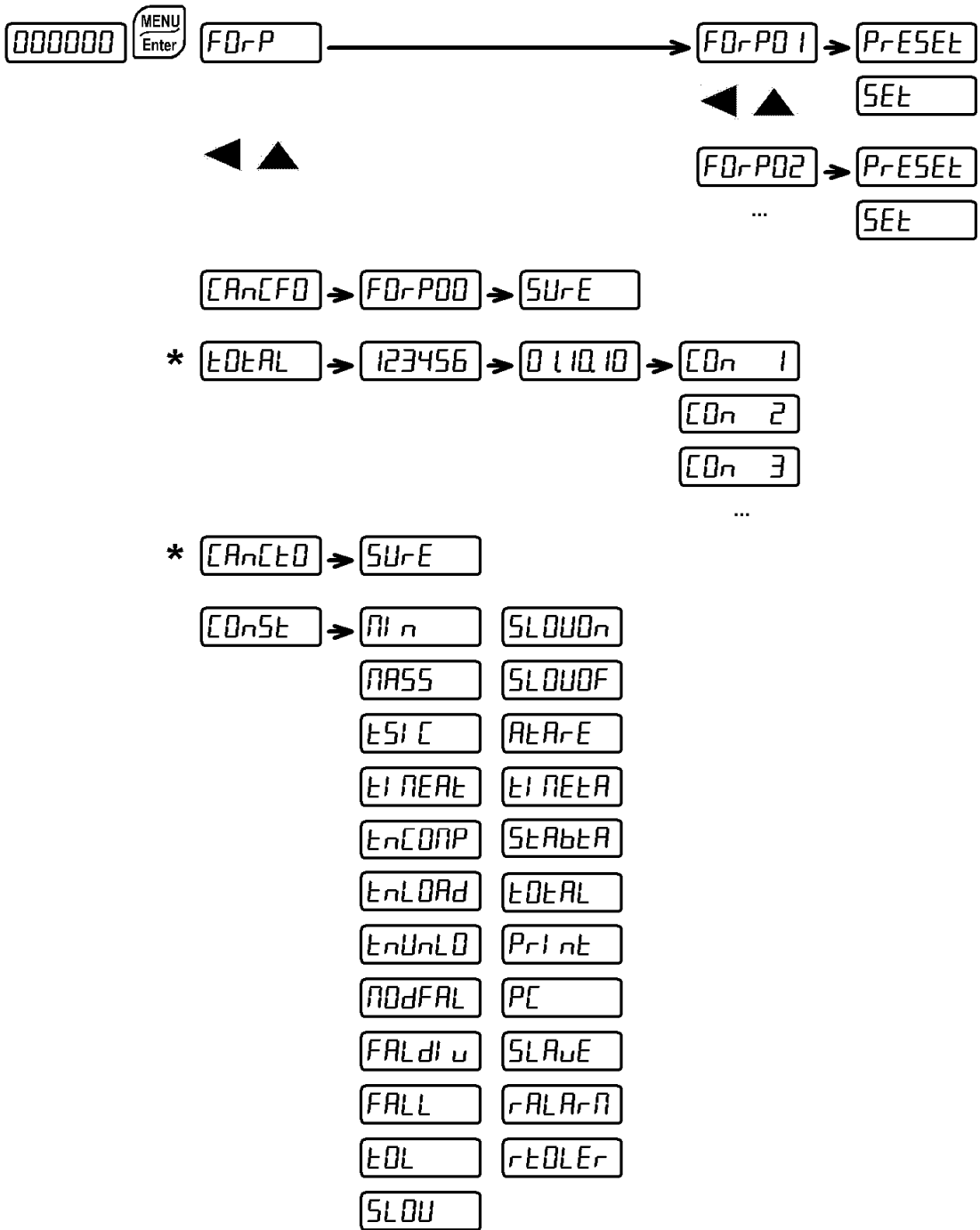

*: it appears only if in constants TOTAL = YES

INSTRUMENT COMMISSIONING

To turn on the instrument press **ON**. To turn it off press **OFF** for about 3 seconds: when **OFF** appears release the key.

After a blackout the instrument DOES NOT come on again automatically, you have to press **ON**. To guarantee an automatic restart after a blackout, disable the ON key (see section **AFTER A BLACKOUT**).

Upon switch-on, the display shows in sequence:

- **111111** → **999999** (ONLY in case of approved program);
- instrument model (e.g.: **UdSH** or **U1 nH** or **UeAb**);
- **SU** followed by the software code (e.g.: **SU 5**);
- program type: **bASE** (base); **LOAD**; **UnLOAD**; **3PrOd**; **6PrOd**; **14PrOd**; **NULLt** (no active program);
- **r** followed by the software version (e.g.: **r 1.04.01**);
- **HU** followed by the hardware code (e.g.: **HU 104**);
- serial number (e.g.: **1005 15**);

Check that the display shows the weight and that when loading the load cells there is an increase in weight. If there is not check and verify the connections and correct positioning of the load cells.

- **If the instrument has already been theoretical CALIBRATED** (plant system identification tag present on the instrument and on the cover: load cell's rated data already entered):
 - Reset to zero (see section **TARE WEIGHT ZERO SETTING**)
 - Check the calibration with sample weights and correct the indicated weight if necessary (see section **REAL CALIBRATION (WITH SAMPLE WEIGHTS)**).
- **If the instrument HAS NOT BEEN CALIBRATED** (missing plant system identification tag) proceed with calibration:
 - If load cells data are unknown, follow the procedure in section **REAL CALIBRATION (WITH SAMPLE WEIGHTS)**
 - Enter the rated data of load cells following the procedure given in section **THEORETICAL CALIBRATION**
 - Reset to zero (see section **TARE WEIGHT ZERO SETTING**)
 - Check the calibration with sample weights and correct the indicated weight if necessary (see section **REAL CALIBRATION (WITH SAMPLE WEIGHTS)**).
- If you use the analog output, set the desired analog output type and the full scale value (see section **ANALOG OUTPUT**).
- If you use serial communication, set the related parameters (see section **SERIAL COMMUNICATION SETTING**).
- Set instrument's clock with current date and time (see section **DATE AND TIME SETTING**)

Required settings for the first batching:

- Access the Batching Constants menu and set the minimum weight value (see section **MINIMUM WEIGHT**);
- Access the System Parameter menu and set the **P55** parameter (see section **OPERATION SETTINGS**);
- Access the Formulas menu and set the formula 01 (see section **FORMULAS PROGRAMMING**);
- Start the batching by pressing the **START** button or by closing the START contact

PROGRAMMING OF SYSTEM PARAMETERS

From the weight display, press simultaneously keys **MENU** and **ESC** to access the parameter setting.

- MENU/ENTER**: to enter a menu/confirm the data entry.
- ▲**: to modify the displayed figure or menu item.
- ◀**: to select a new figure or modify the displayed menu item.
- ESC**: to cancel and return to the previous menu.

THEORETICAL CALIBRATION



This function allows the load cell rated values to be set.

To perform the theoretical calibration set the following parameters in sequence:

- **F5-tE0** (Default: **dEN0**): The **system full scale** is given by one cell capacity multiplied by the number of cells used. Example: 4 cells of 1000 kg → FULL SCALE = 1000 x 4 = 4000. The instrument is supplied with a theoretical full scale value **dEN0** corresponding to 10000. To restore factory values, set 0 as full scale.
- **SErSI b** (Default: 2.00000 mV/V): **Sensitivity** is a load cell rated parameter expressed in mV/V. Set the average sensitivity value indicated on the load cells. It's possible to set a value between 0.50000 and 7.00000 mV/V. Example of 4-cell system with sensitivity: 2.00100, 2.00150, 2.00200, 2.00250; enter 2.00175, calculated as $(2.00100 + 2.00150 + 2.00200 + 2.00250) / 4$.
- **dI UI S**: The **division** (resolution) is the minimum weight increment value which can be displayed. It is automatically calculated by the system according to the performed calibration, so that it is equal to 1/10000 of full scale. It can be changed and be variable between 0.0001 and 100 with x1 x2 x5 x10 increments.



- By modifying the theoretical full scale, the sensitivity or divisions, the real calibration is cancelled and the theoretical calibration only is considered valid.
- If the theoretical full scale and the recalculated full scale in real calibration (see section **REAL CALIBRATION (WITH SAMPLE WEIGHTS)**) are equal, this means that the calibration currently in use is theoretical; if they are different, the calibration in use is the real calibration based on sample weights.
- By modifying the theoretical full scale, the sensitivity or divisions and all the system's parameters containing a weight value will be set to default values.

TARE WEIGHT ZERO SETTING



This menu may also be accessed directly from the weight display, holding down the key for 3 seconds.

Perform this procedure after having set the THEORETICAL CALIBRATION data.

Use this function to set to zero the weight of the empty system after commissioning and then later on to compensate zero variations due to the presence of product residues.

Procedure:

- Confirm the message **ZEr0** (Zero) by pressing .
- The weight value to be set to zero is displayed. In this phase all of the LEDs are flashing.
- Confirming once again, the weight is set to zero (the value is stored to the permanent memory).
- Press to display the value of the total weight reset by the instrument, given by the sum of all of the previous zero settings.

ZERO VALUE MANUAL ENTRY



WARNING: Perform this procedure only if it's not possible to reset the weighed structure tare, for example because it contains product that can not be unloaded.

Set in this parameter the estimated zero value (from 0 to max 999999; default: 0).

REAL CALIBRATION (WITH SAMPLE WEIGHTS)



After having performed the THEORETICAL CALIBRATION and TARE WEIGHT ZERO SETTING, this function allows correct calibration to be done using sample weights of known value and, if necessary, any deviations of the indicated value from the correct value to be corrected.

Load onto the weighing system a sample weight, which must be **at least 50%** of the maximum quantity to be weighed.

By confirming the message **UEI GHE** the flashing value of the weight currently on the system is displayed. In this phase all of the LEDs are off. Adjust the value on display by using the arrow keys if necessary. After confirming, the new set weight will appear with all the LEDs flashing.

After an additional confirmation, the message **UEI GHE** will be restored and by repeatedly pressing the key the weight will once again be displayed.

Example: for a system of maximum capacity 1000 kg and 1 kg division, two sample weights are available, one of 500 kg and the other one of 300 kg. Load both weights onto the system and correct the indicated weight to 800. Now remove the 300 kg weight, the system must show 500; remove the 500 kg weight, too; the system must read zero. If this does not happen, it means that there is a mechanical problem affecting the system linearity.

WARNING: identify and correct any mechanical problems before repeating the procedure.



- If theoretical full scale and recalculated full scale in real calibration are equal, it means that the theoretical calibration is currently in use; otherwise, the real calibration based on sample weights is in use.
- If the correction made changes the previous full scale for more than 20%, all the parameters with settable weight values are reset to default values.

LINEARISATION OPTION ON MAX 5 POINTS:

It is possible to perform a linearisation of the weight repeating the above-described procedure up to a maximum of five points, using five different sample weights. The procedure ends by pressing the **ESC** button or after entering the fifth value; at this point it will no longer be possible to change the calibration value, but only to perform a new real calibration. To perform a new calibration, should return to the weight display and then re-entering into the calibration menu.

By pressing **▲** after having confirmed the sample weight that has been set, the full scale appears, recalculated according to the value of the maximum sample weight entered and making reference to the cell sensitivity set in the theoretical calibration (**SEnSi b**).

FILTER ON THE WEIGHT



Setting this parameter allows a stable weight display to be obtained.

To increase the effect (weight more stable) increase the value (from 0 to 9, default 4).

As seen in the diagram:

- By confirming the **FILTER** message, the currently programmed filter value is displayed.
- By changing and confirming the value, the weight is displayed and it will be possible to experimentally verify its stability.
- If stability is not satisfactory, confirming brings back the message **FILTER** and the filter may be modified again until an optimum result is achieved.

The filter enables to stabilise a weight as long as its variations are smaller than the corresponding "response time". It is necessary to set this filter according to the type of application and to the full scale value set.

FILTER VALUE	Response times [ms]	Display and serial port refresh frequency [Hz]
0	12	300
1	150	100
2	260	50
3	425	25
4 (default)	850	12.5
5	1700	12.5
6	2500	12.5
7	4000	10
8	6000	10
9	7000	5

ZERO PARAMETERS



RESETTABLE WEIGHT SETTING FOR SMALL WEIGHT CHANGES

0 SEt (from 0 to max full scale; default: 300; considered decimals: 300 – 30.0 – 3.00 – 0.300): this parameter indicates the maximum weight value resettable by external contact, keypad or serial protocol.

AUTOMATIC ZERO SETTING AT POWER-ON

AUTO 0 (from 0 to max 20% of full scale; default: 0): If at switch-on the weight value is lower than the value set in this parameter and does not exceed the **0 SEt** value, the weight is reset. To disable this function, set 0.

ZERO TRACKING

TRAC 0 (from 1 to 5, default: **nOnE**): When the weight value is stable and, after a second, it deviates from zero by a figure in divisions smaller or equal to the figure in divisions set in this parameter, the weight is set to zero. To disable this function, set **nOnE**.

Example: if the parameter **dI UI 5** is set to 5 and **TRAC 0** is set to 2, the weight will be automatically set to zero for variations smaller than or equal to 10 (**dI UI 5** x **TRAC 0**).

SETTING UNITS OF MEASURE



These are the available units of measure:

- HI LOG:** kilograms
- G:** grams
- t:** tons
- Lb:** pounds
- nEUton:** newtons
- LI t r E:** litres
- bAr:** bars
- Atm:** atmospheres
- PIECE:** pieces
- nEU-M:** newton metres
- HI LO-M:** kilogram metres
- Other:** other generic units of measure not included in the list

If the print function is enabled, the symbol corresponding to the selected unit of measure will be printed after the measured value.

OUTPUTS AND INPUTS CONFIGURATION



OUTPUTS

- OUTPUT 1: PRESET (for operation see **OPERATION SETTINGS**)
- OUTPUT 2: SET (for operation see **OPERATION SETTINGS**)
- OUTPUT 3: CYCLE END (the relay is closed to the achievement of Cycle End)
- OUTPUT 4: ALARM (the relay is closed when an alarm is present)
- OUTPUT 5: TOLERANCE (the relay is closed when the weight is out of tolerance)

INPUTS

- INPUT 1: START
- INPUT 2: STOP
- INPUT 3 (Default = **ZERO**): It's possible to select one of the following functions:
 - **NET-GROSS**: by closing this input for no more than one second, it's making an operation of SEMI-AUTOMATIC TARE and the display will show the net weight. To display the gross weight again, hold the NET/GROSS input closed for 3 seconds.
 - **SEMI-AUTOMATIC ZERO**: by closing the input for no more than one second, the weight is set to zero (see section **SEMI-AUTOMATIC ZERO (WEIGHT ZERO-SETTING FOR SMALL VARIATIONS)**).
 - **APPROVAL**: the instrument starts the batching only after verifying that this input is closed.

SEMI-AUTOMATIC TARE (NET/GROSS)



THE SEMI-AUTOMATIC TARE OPERATION IS LOST UPON INSTRUMENT POWER-OFF.

To perform a net operation (SEMI-AUTOMATIC TARE), close the NET/GROSS input or press the **TARE** key for less than 3 seconds. The instrument displays the net weight (just set to zero) and the NET LED lights up. To display the gross weight again, keep the NET/GROSS input closed or press **TARE** for 3 seconds.

This operation can be repeated many times by the operator to allow the loading of several products.

Example:

Put the box on the scale, the display shows the box weight; press **TARE**, the display shows the net weight to zero; introduce the product in the box, the display shows the product weight. This operation can be repeated several times.



While the net weight is displayed, keep  pressed to display gross weight. When the key is released the net weight will be displayed again.

The semi-automatic tare operation is not allowed if the gross weight is zero.

PRESET TARE (SUBTRACTIVE TARE DEVICE)



While the net weight is displayed, keep  pressed to display the gross weight. When the key is released the net weight will be displayed again.



- IF A SEMI-AUTOMATIC TARE (NET) IS ENTERED, IT IS NOT POSSIBLE TO ACCESS THE ENTER PRESET TARE FUNCTION.
- IF A PRESET TARE IS ENTERED, IT'S STILL POSSIBLE TO ACCESS THE SEMI-AUTOMATIC TARE (NET) FUNCTION. THE TWO DIFFERENT TYPES OF TARE ARE ADDED.



ALL THE SEMI-AUTOMATIC TARE (NET) AND PRESET TARE FUNCTIONS WILL BE LOST WHEN THE INSTRUMENT IS TURNED OFF.

WDESK, WINOX

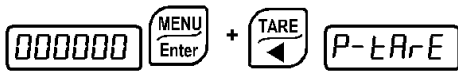

It is possible to manually set a preset tare value to be subtracted from the display value provided that the $P-TARE \leq \text{max weight condition}$ is verified.

By default the instrument shows the last programmed preset tare value: to apply it press  and then **ENTER**.

After setting the tare value, going back to the weight display, the display shows the net weight (subtracting the preset tare value) and the NET LED lights up to show that a tare has been entered. To delete a preset tare and return to gross weight display, hold down **TARE** for about 3 seconds or keep the NET/GROSS input (if any) closed for the same length of time (3 seconds). The preset tare value is set to zero. The NET LED is turned off when the gross weight is displayed once again.

WTAB



It is possible to manually set up to 9 different preset tare values to be subtracted from the display value provided that the $P-TARE \leq \text{max weight condition}$ is verified.

To apply one of the 9 tares, enter the corresponding menu, display the set value, change it if necessary and press **ENTER**. Going back to the weight display, the display shows the net weight (subtracting the preset tare value) and the NET LED lights up to show that a tare has been entered. To disable the preset tare and return to gross weight display, hold down **PTARE** or **TARE** for about 3 seconds or keep the NET/GROSS input (if any) closed for the same length of time (3 seconds). The NET LED is turned off when the gross weight is displayed once again.

SEMI-AUTOMATIC ZERO (WEIGHT ZERO-SETTING FOR SMALL VARIATIONS)

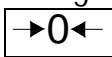
By closing the SEMI-AUTOMATIC ZERO input, the weight is set to zero; alternatively, by pressing the  key for less than 3 seconds, the **SEt0rEP** message is displayed for 3 seconds, by pressing **ENTER** the weight is set to zero.

This function is only allowed if the weight is lower than the **0 SEt** value (see section **RESETTABLE WEIGHT SETTING FOR SMALL WEIGHT CHANGES**), otherwise the alarm **E-----** appears and the weight is not set to zero.

ANALOG OUTPUT(ONLY FOR INSTRUMENTS WHERE THIS OPTION IS AVAILABLE)



- **TYPE:** it selects the analog output type (4÷20 mA, 0÷20 mA, 0÷10 V, 0÷5 V, ±10 V, ±5 V; default: 4÷20 mA).



For the output ±10 V and ±5 V the soldered jumper SW1 must be closed:

- open the instrument;
- locate on the analog board, which is mounted perpendicular to the main board, the soldered jumper SW1 highlighted in the picture below:

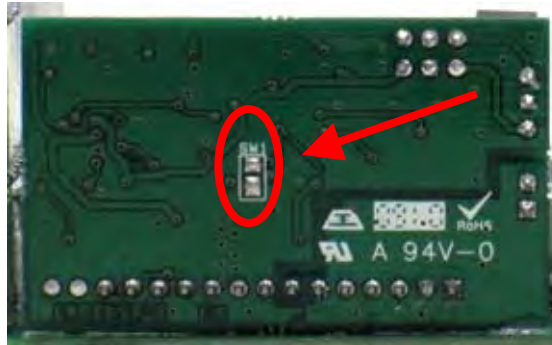

- close the jumper shorting the pads with a drop of tin.

- **MODE:** choice of a weight followed by the analog output: gross (**GROSS**) or net (**NET**). If the net function is not active, the analog output varies according to gross weight.
- **ANA 0:** set the weight value for which you wish to obtain the minimum analog output value.



Only set a value different from zero if you wish to limit the analog output range; for instance: for a full scale value of 10000 kg you require an 4 mA signal at 5000 kg and 20 mA at 10000 kg, in this case, instead of zero, set 5000 kg.

- **ANA FS:** set the weight value for which you wish to obtain the maximum analog output value; it must correspond to the value set in the PLC program (default: calibration full scale). E.g.: if I am using a 4÷20 mA output and in the PLC program I wish to have 20 mA = 8000 kg, I will set the parameter to 8000.
- **CO- 0:** analog output correction to zero: if necessary adjust the analog output, allowing the PLC to indicate 0. The sign "-" can be set for the last digit on the left. E.g.: if I use a 4÷20 mA output and, with the minimum analog setting, the PLC or tester read 4.1 mA, I must set the parameter to 3.9 to obtain 4.0 on the PLC or tester.
- **CO- FS:** correction of analog output to full scale: if necessary permit modification of the analog output by allowing PLC to indicate the value set in the parameter **ANA FS**. E.g. if I am using a 4÷20 mA output with the analog set to full scale and the PLC or tester reads 19.9 mA, I must set the parameter to 20.1 to get 20.0 on the PLC or tester.

Minimum and maximum values which can be set for zero and full scale corrections:

ANALOG OUTPUT TYPE	Minimum	Maximum
0÷10 V	-0.150	10.200
0÷5 V	-0.150	5.500
±10 V	-10.300	10.200
±5 V	-5.500	5.500
0÷20 mA	-0.200	22.000
4÷20 mA	-0.200	22.000

NOTE: the analog output may also be used in the opposite manner, i.e. the weight setting that corresponds to the analog zero (**ANA 0**) may be greater than the weight set for the analog full scale (**ANA F5**). The analog output will increase towards full scale as the weight decreases; the analog output will decrease as the weight increases.

For example:

ANA 0 = 10000 ANA F5 = 0 analog output 0÷10 V

Weight = 0 kg analog output = 10 V

Weight = 5000 kg analog output = 5 V

Weight = 10000 kg analog output = 0 V

SERIAL COMMUNICATION SETTING

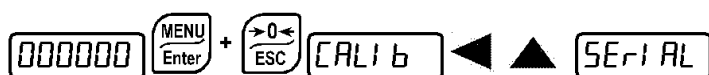

- **r5485 / r5232**: communication port.
 - **nOnE**: it disables any type of communication (default).
 - **ModBUS**: MODBUS-RTU protocol; possible addresses: from 1 to 99 (see Communication protocols manual).
 - **rIP**: continuous weight transmission protocol to RIP5/20/60, RIP50SHA, RIPLEd series remote displays; the remote display shows the net weight or gross weight according to its settings (set: **bAUd** = 9600, **PARi tY** = nOnE, **StOP** = 1).
 - **Hdri P**: continuous weight transmission protocol to RIP675, RIP6125C series remote displays; the remote display shows the net weight or gross weight according to its settings (set: **bAUd** = 9600, **PARi tY** = nOnE, **StOP** = 1).
 - **Hdri Pn**: continuous weight transmission protocol to RIP675, RIP6125C series remote displays (set: **bAUd** = 9600, **PARi tY** = nOnE, **StOP** = 1).
When the remote display is set to gross weight:
 - if the instrument displays the gross weight, the remote display shows the gross weight.
 - if the instrument shows the net weight, the remote display shows the net weight alternated with the message **nEt**.
 - **PrI ntr**: printer.
 - **bAUd**: transmission speed (2400, 4800, 9600, 19200, 38400, 115200; default: 9600).
 - **Addr**: instrument address (da 1 a 99; default: 1).
 - **dELAY**: delay in milliseconds which elapses before the instrument replies (from 0 to 200 ms; default: 0).
 - **PARi tY**:
 - **nOnE**: no parity (default).
 - **EUEn**: even parity.
 - **Odd**: odd parity.
 - **StOP**: stop bit (1 – 2; default: 1).
 - **ENPtY**: number of blank lines between one printout and the next.
 - **HEAdEr**: printing of custom heading from PC (**YES** – **n0**; default: **n0**).
 - **PrtNOd**: connected printer type:
 - **P 190**
 - **StAUP**
 - **StAUE**
 - **PLUSI I** (WTAB ONLY)



For more information about protocols and methods of communication, request the proper manual to technical assistance.

RS232 SERIAL COMMUNICATION

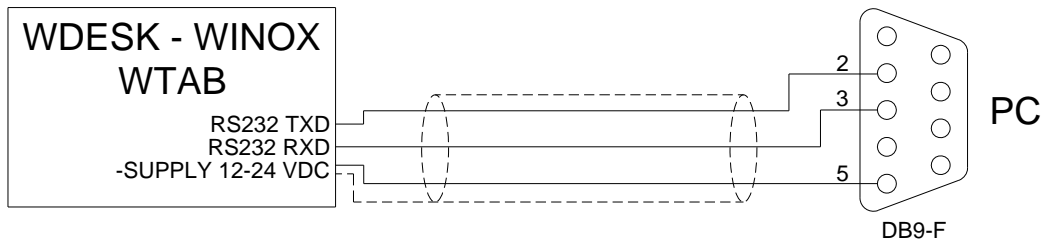

RS485 SERIAL COMMUNICATION

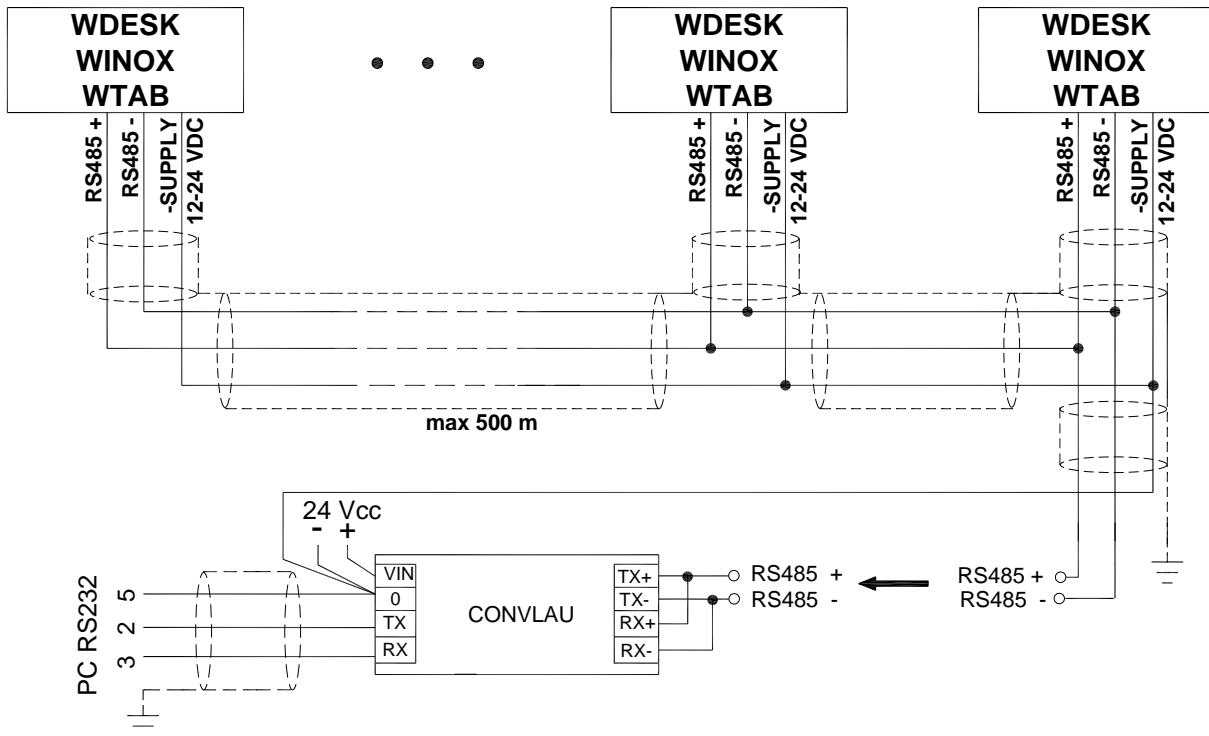

If the RS485 network exceeds 100 metres in length or baud-rate over 9600 are used, two terminating resistors are needed at the ends of the network. Two 120 ohm resistors must be connected between the “+” and “-” terminals of the line, on the terminal strip of the furthest instruments. Should there be different instruments or converters, refer to the specific manuals to determine whether it is necessary to connect the above-mentioned resistors.

DIRECT CONNECTION BETWEEN RS485 AND RS232 WITHOUT CONVERTER

Since a two-wire RS485 output may be used directly on the RS-232 input of a PC or remote display, it is possible to implement instrument connection to an RS-232 port in the following manner:

INSTRUMENT	→	RS232
RS485 -	→	RXD
RS485 +	→	GND



This type of connection allows A SINGLE instrument to be used in a ONE WAY mode.

ALARM RELAY CLOSURE



The ALARM relay closing can be enabled or disabled for each of the following alarms: approval contact (**CO_nSP**); formula not programmed (**ENP_EY**); maximum weight exceeded (**MA_SFO_r**); minimum weight (**EA_rE**); no increase in weight (**LOAd**); no decrease in weight (**UnLOAD**); fall (**FALL**); the PC did not read the batching data (**SLA_UE**).

YES: in presence of alarm, the relay is closed (default)

n0: the relay is not closed even in the presence of alarm

TEST



- **Input Test:**

I n: ensure that for each open input **0** is displayed, **I** is displayed when the input is closed.

- **Output Test:**

0u_t: setting **0** ensure that the corresponding output opens. Setting **I** ensure that the corresponding output closes.

- **E/EC Option Test:**

EE: It shows the formula selected by the E/EC option, if the option is not present or is not active, the message **EE-Er** is displayed.

- **Analog Output Option Test:**

AnALOG: It allows the analog signal to range between the minimum and the maximum values starting from the minimum.

IA: current output test.

vOL_t: voltage output test.

- **Millivolt Test:**

mV-CEL: displays the load cell response signal in mV with four decimals.

ENERGY SAVING

WDESK-R, WINOX-R, WTAB-R



- **On**: display always on;
- **CHANGE**: the display enters energy saving mode after about one minute of no activity; pressing a key or a weight change turns normal operations on again.

WDESK-L, WINOX-L, WINOX-2L, WTAB-L



- **On**: back-lighting on;
- **OFF**: back-lighting off;
- **CHANGE**: back-lighting goes off after about one minute of no activity; pressing a key or a weight change turns it on again.

DATE AND TIME SETTING



Selecting the **dAtE** item in the main menu, access is obtained to the date and time display menu. Pressing **ENTER** several times scrolls through days - months - years and hours - minutes; pressing **◀** selects the figure to modify; pressing **▲** the figure increases; pressing **ENTER** you can confirm and go to the next menu item.

OPERATION SETTINGS



nEHt P: Select the switch conditions from the SET opening to the CYCLE END closing.

- **tI nE** (Default: **YES**): time set in constants (**tI nEAt**).
- **CONAnd** (Default: **n0**): START input closure or **ENTER** key pressure.
- **StAbLE** (Default: **n0**): stable weight.

P55 (Default: **2**): Select the operating mode of SET and PRESET contacts.

- **P55 = 1**: at the batching start, only the PRESET contact is closed; once reached the preset set value, the related contact is opened and the SET contact is closed; reached the final value of set, the related contact is opened.
- **P55 = 2**: at the batching start, the SET and PRESET contacts are closed simultaneously; once reached the preset value, the related contact is opened (beginning of the slow phase); once reached the set value, also the related contact is opened. For single-speed batching, program **P55 = 2** and use only the SET contact.
- **P55 = 3**: at the batching start, only the PRESET contact is closed; once reached the preset value, also the SET contact is closed; once reached the final value of set, both are reopened.

EndnEt (Default: **n0**): Select the display type of net / gross weight during the CYCLE END phase (unloading of the scale at the end of batching).

- **YES**: during the cycle end, the net weight is displayed. After the CYCLE END opening, the gross weight is displayed.
- **n0**: during the cycle end, the gross weight is displayed.

bLACH (Default: **nAn**): Select the batching resume mode after a power failure.

- **Aut**: (Automatic) at the power restore, **bLACH** appears for 3 seconds, after which the batching resumes from the point of interruption.
- **nAn**: (Manual) at the power restore **bLACH** appears, press **ENTER** to resume the batching or press **ESC** to stop it.

INFO MENU



OP2: active options are displayed.

PROGRAMMING OF BATCHING CONSTANTS

From weight display press **MENU**, then press **▲** several times until **COnt** is displayed and confirm.

- MENU/ENTER**: to enter a menu/confirm the data entry.
▲: to modify the displayed figure or menu item.
◀: to select a new figure or modify the displayed menu item.
ESC: to cancel and return to the previous menu.

MINIMUM WEIGHT

Min (from 0 to max full scale; default: 10): minimum weight, value at which the scale is considered empty. Batching start is only allowed if the weight is lower than this value, during the unloading phase the CYCLE END contact will be opened when the weight reaches this value and after the safe emptying time is over.

MAXIMUM WEIGHT

MASS (from 0 to max full scale; default: 0): settable and displayable maximum weight. If the displayed weight exceeds the maximum weight by 9 divisions, the "-----" message is displayed; if in the formulas programming the weight value set is greater than this value, the **Error** message is displayed and the value will not be stored.
By setting 0, the function is disabled.

SAFE EMPTYING TIME

ESIT (from 0.0 to max 999.9 seconds; default 5.0): time that is necessary for a perfect emptying of the scale. The instrument waits for this time during the unloading phase (CYCLE END closed), after reaching the minimum weight and before opening the CYCLE END contact to obtain a perfect emptying of the scale.

WAITING TIME

ELPWT (from 0.0 to max 999.9 seconds; default 5.0): time elapsing between the SET end batching and the CYCLE END closing to allow the weight to get steady. This waiting time is only required if the automatic fall is programmed and/or consumption is enabled and/or printing is enabled and/or a tolerance value has been programmed and/or confirmation from PC is enabled and/or USB option is present and/or DATIPC option is present.

NO COMPARISON TIME

LnCOMP (from 0.0 to max 999.9 seconds; default: 0.0): this is the instrument waiting time during batching, after the opening of PRESET, before comparing the weight with the programmed SET value.

NO PRODUCT LOAD TIME

LnLOAD (from 0.0 to max 999.9 seconds; default: 0.0): this parameter allows the product control during batching. if there is no product load, the instrument waits for a set duration of time before activating the alarm **LOAD**.

NO PRODUCT UNLOAD TIME

LnUnLO (from 0.0 to max 999.9 seconds; default: 0.0): this parameter allows the product control during the unloading phase (cycle end). If there is no product extraction, the instrument waits for a set duration of time before activating the alarm **UnLOAD**.

WARNING: The control is only actuated after unloading of the product has started (the weight must decrease by at least 10 divisions).

FALL

By FALL it means the correction of the product amount in fall after the batching STOP. This amount is in addition to the product already batched causing inaccuracy. The instrument is able to anticipate the batching STOP, to reduce this uncertainty, with two possible ways:

- AUTOMATIC fall: the instrument automatically calculates the fall;
- MANUAL fall: the instrument applies the fall set by the operator;

WARNING: Setting a value of **WAITING TIME (E1 PERE)** such that the weight is stable at the end of the batching, otherwise the update of the AUTOMATIC fall is not correct.

NOdFAL

NOdFAL (from 1 to max 99; default: 0): it's possible to select the automatic or the manual fall.

- **NOdFAL** = 0: MANUAL fall;
- **NOdFAL** different from 0: AUTOMATIC fall (the set value shows how many batchings the fall value is updated).

Note: In the batching cycles in which the fall value is not updated, the **WAITING TIME** is not applied, unless there are no other functions that require the **WAITING TIME** (eg prints...). So, by setting a high value, it reduces the duration of batchings.

Example: If **NOdFAL** = 3 the AUTOMATIC fall is calculated every three batching cycles.

FALDI (only if NOdFAL is different from 0)

FALDI (from 0 to max full scale; default: 0): this parameter indicates the limit within which the automatic fall is updated according to the parameter **NOdFAL**. By setting a low value is obtained more accurately but the length of the batchings could increase, because, if necessary, the AUTOMATIC fall is updated every cycle regardless of **NOdFAL**. By setting 0, the function is disabled.

Example: By setting **NOdFAL** = 3, **FALDI** = 5 and the weight equal to 100, the instrument updates the fall every batching, until the batched weight falls within the 95 to 105 range, and then it goes back to update the AUTOMATIC fall every 3 batchings.

FALL

FALL (from 0 to maximum weight; default: 0): in this parameter it is possible to set the fall value for each formula (only if **NOdFAL** = 0) or to display and/or to modify the fall value calculated automatically by the instrument (only if **NOdFAL** is different from 0).

TOLERANCE

TOL (from 0 to maximum weight; default: 0): Adjustable parameter for each formula that defines how much the batched weight value can deviate from the one set in formula. If the batched weight is higher or lower than the amount to be batched, for a value greater than the tolerance, the instrument closes the TOLERANCE contact. Press **ENTER** to continue the batching; the TOLERANCE contact remains closed until the weight reaches the minimum weight value and the safe emptying time has elapsed. Example: if a SET = 1000 value is set and a TOLERANCE = 100 value is set, the batched weight must not be lower than 900 or higher than 1100 to allow the instrument to continue the batching process. By setting 0, the function is disabled.

SLOW

SLOW (from 0 to maximum weight; default: 0): single valid value for all the formulas in place of the preset value. When the weight has reached the SET value minus the value set in this parameter, the slow batching phase starts by the PRESET contact. If the set value is greater than the weight to batch, the batching will be in slow phase. By setting 0, the function is disabled.

Example: If SET = 100 and SLOW = 15, the slow phase begins when the weight reaches 85.

TAPPING FUNCTION

In the event that the batching instrument is not equipped with the speed "slow" it is possible to use this function to slow down the product batching in the final phase (through opening and closing cycles of the SET contact) and to increase the accuracy. Set in **SLOW** parameter the product amount you want to batch with the tapping function enabled.

SLOW ON

SLOWON (from 0 to max 9.9; default: 0): time in which the SET relay remains closed during the SLOW phase. By setting 0, the function is disabled.

SLOW OFF

SLOWOFF (from 0 to max 9.9; default: 0): time in which the SET relay remains open during the SLOW phase. By setting 0, the function is disabled.

AUTOTARE

AUTARE (from 0 to 999; default: 0): autotare enabling (automatic tare at batching start); the autotare will be updated every as many cycles of a single batching sequence as are set in this parameter. By setting 0, the function is disabled.

This operation is possible only if the gross weight is lower than the minimum weight (**MIN**), otherwise the **ALARM** alarm message is displayed.

AUTOTARE DELAY

ELPESA (from 0 to max 99.9; default: 0): the instrument waits for this time, after the starting of the formula, before performing the autotare and starting the batching.

STABLE TARE

STABTAR (default: **NO**): autotare enabled at stable weight.

- **YES**: if autotare enabled, zero-setting at batching start is done after a possible delay time and only when the weight is stable.
- **NO**: if autotare enabled, zero-setting is done right after the delay time.

CONSUMPTION FOR EACH FORMULA

GLOBAL (default **NO**): enabling consumption memory (total batched quantity) for each formula.

- **YES**: consumption enabled
- **NO**: consumption disabled.

PRINT AT CYCLE END

Print (Default **NO**): function enabling to print batching data at cycle end.

- **YES**: print enabled
- **NO**: print disabled

CHECKING PC PRESENCE

PC (Default: **n0**): check for a PC connected to the instrument.

- **YES**: PC presence check active; the instrument checks for a PC every 10 seconds. If no PC presence is detected, the instrument will display an alarm signal **PC** alternated with the weight value.
- **n0**: PC presence check not active.

WARNING: The check is active only if selected the Modbus protocol.

WAITING CONFIRMATION FROM PC (SLAVE)

SLAVE (Default: **n0**): waiting for confirmation of record batching data from PC.

- **YES**: check enabled; the instrument waits for the PC to read the batching data, before starting another batching. In case of recording failure, the instrument displays an alarm **SLAVE**.
- **n0**: check disabled; at cycle end, the instrument will not wait for data recording on PC before performing another batching.

SWITCHING OF THE ALARM RELAY ON WEIGHT

rALARn (from 0 to max full scale; Default: 0): by setting a value different from zero, the ALARM contact does not switch over in case of alarm, but behaves as a SETPOINT contact; the relay closes when the weight reaches the value set in this parameter.

SWITCHING OF THE TOLERANCE RELAY ON WEIGHT

rTOLER (from 0 to max full scale; Default: 0): by setting a value different from zero, the TOLERANCE contact does not switch on the basis of tolerance, but behaves as a SETPOINT contact; the relay closes when the weight reaches the value set in this parameter.

FORMULAS PROGRAMMING

Select the formula that you wish to program and set *PrESEt* and *SEt*.
It is possible to set max 99 formulas.

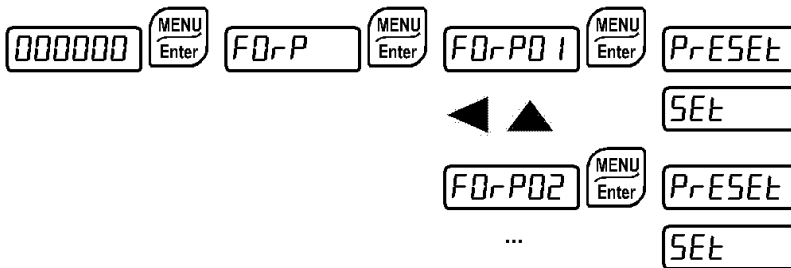

PrESEt is NOT displayed if a *SLOW* value has been set in the constants (*SLDU*).

In case of attempt in *PrESEt* or *SEt* to set a value higher than the maximum weight (*MASS*) set in the batching constants, the message *Error* is displayed.

DELETING FORMULAS

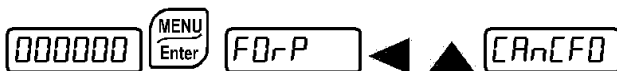

Confirm with **ENTER** the **CArCFD** prompt, to delete one formula enter the formula number, to delete all formulas enter 00 (**FOrP00**), confirm with **ENTER**, you will be prompted to confirm (**SUrE**), to delete confirm again with **ENTER** otherwise press **ESC** to cancel the command.

BATCHING

Note: In case of alarm, the batching may be canceled by pressing the ESC button or by closing the STOP input.

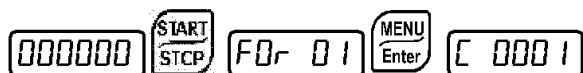

After having selected the formula and set the desired number of batching cycles, the first batching cycle starts as follows:

1. The instrument will ensure that:
 - the formula has been programmed, otherwise it will display the alarm **EMPTY**.
 - the amount set in the formula does not exceed the set maximum weight (**PASS**), otherwise the message **PASSFOR** is displayed.
 - IN3 input (if it is set as Approval) is closed, otherwise the message **CLOSEP** will be displayed; close the IN3 input to start the batching.
 - the gross weight is lower than the minimum weight (**MIN**), otherwise the alarm **TAKE P** is displayed (however it is possible to force batching start by pressing ENTER).
 - Only if **EDLAL = YES**:
 - If the consumed amount exceeds 999000, the **EDLAL** message appears for a second.
 - If the consumed amount exceeds 999999, it is automatically set to zero.
2. Once the above listed conditions are met, the batching is started and the SET and PRESET contacts switch depending on the **PSS** parameter (see section **OPERATION SETTINGS**). From now on, we assume the parameter **PSS = 2** (default); so that, SET and PRESET are closed.
3. If during the batching, after setting the time **enLOAD**, the product is not loaded by at least 20 divisions within this interval of time, the **LOADP** alarm message will be displayed.
4. The PRESET contact will be opened, as soon as one of the following conditions is reached:
 - Only if **SLOW** is set: once reached the set value minus the slow value;
 - Once reached the preset value set in formula;
5. If a tapping value has been set, the SET contact will be opened and closed according to the **SLOWON** and **SLOWOFF** times;
6. Only if **enCOMP** is set: the instrument does not verify the reaching of Set value until the **COMPARISON TIME** has elapsed.
7. As soon as the SET value in the formula minus the possible fall value is reached, the SET contact will be opened and the product flow will be interrupted;
8. After the opening of the SET contact, the system shows the weight preceded by the letter **A** and waits:
 - Only if **ELNE = YES**: the waiting time has elapsed (**ELNEAL**).
 - Only if **CONFAND = YES**: the START input has been closed or the ENTER key has been pressed.
 - Only if **STABLE = YES**: the weight is stable.
9. If the tolerance (**EDL**) is set and the batched quantity is lower than the set quantity minus this value, is made only one attempt of finishing re-start, in order to improve the batching precision. In such a case, the SET contact is closed and returns to step 7, otherwise the **EDL** alarm appears. In instead, the batched quantity is greater than the set amount plus this value, the **EDL** alarm appears. Press ENTER to cancel the alarm and go on with the batching.
10. The system enters the cycle end phase:

- The CYCLE END contact is closed;
 - The display shows the weight preceded by the letter **E**;
 - Only if **Print** = **YES**: batching data (with date and time) are printed.
 - Only if **ETOTAL** = **YES**: consumption is stored.
11. At the beginning of the product extraction, if the **UnLOAD** time is set and the product is not extracted by at least 20 divisions within this interval of time, the **UnLOAD** alarm message will be displayed.
 12. The system ends the batching (opening of the CYCLE END contact) only after verifying that:
 - The weight is lower than the minimum weight (**Min**);
 - The safe emptying time has elapsed (**ETC**);
 13. Only if **SLAVE** = **YES**: the instrument waits for data recording on PC, before being available for a new batching.

If several batching cycles have been set the instrument starts a new cycle.

BATCHING START FROM EXTERNAL CONTACT

It is possible to select the required formula via an external selector switch. After selecting the formula, close the START external contact for at least 0.5 seconds and, verified the conditions indicated in section **BATCHING**, the instrument will perform the selected formula batching.

If there is no the formula selection switch (E/EC options), the latest formula entered via the keypad will be batched, or it's possible to set the required formula in the following menu: press the **MENU** key for 3 seconds, **FES00** will be displayed, set the required formula number using the arrow keys and confirm with **ENTER**. At batching start, the set formula will be performed. If 00 is set, the latest formula set via keypad will be recalled.



If at the end of the batching, the START contact is closed, the same batching sequence is repeated.

DISPLAYING DURING BATCHING

During the batching the display shows the weight preceded by the letter **b**.

By pressing **▲** the formula number is displayed, by pressing it again the number of running cycle is displayed.

BATCHING STOP

- Open the START contact and close the STOP contact to stop the batching. If the START contact is closed, the **START** alarm is displayed.
- To pause the batching at any time, press **STOP**, the **PAUSE** prompt is displayed. Press **ENTER** to resume the batching or press again **STOP** to cancel it definitely.

RESUME BATCHING AFTER A POWER CUT

If a blackout occurs during the batching (unloading phase included), when power comes back **BLACH** appears: press **ENTER** to resume batching from the point of interruption, press **ESC** to cancel the batching and return to the weight displaying.



If in constants **BLACH = AUT**, when power comes back **BLACH** appears and after 3 seconds the batching is automatically resumed.

Power failures do not cause any deletion of cycles still to be performed.

CONSUMPTION

If in constants consumption is enabled ($\text{tOEt} = \text{YES}$), the quantities batched for each formula are stored.

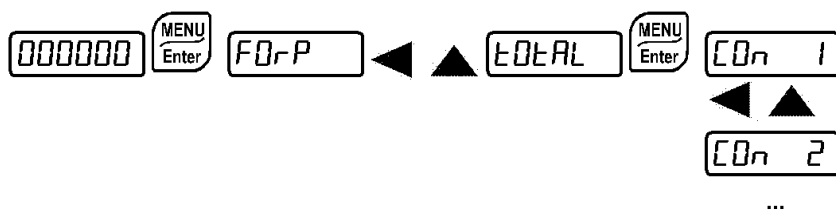

Selecting **tOEtAL** the following information is displayed:

- total quantity consumed for all formulas (divided by 100);
- deletion data;
- quantity consumed for each formula with no decimals.

The quantities will be printed out in full (with decimals).

CONSUMPTION DELETION



To delete consumption confirm **CA_nEtO**, the **SUrE** deletion confirmation is requested; confirm again with **ENTER** or press **ESC** to cancel the command.

If the printer is enabled (see section **SERIAL COMMUNICATION SETTING**) an operation receipt is printed.

ALARMS

- hArEP:** it is displayed if, at batching start, the weight on the scale is higher than the minimum set in constants (π/n). Press **ESC** to return to the weight displaying, press **ENTER** to cancel the alarm and continue with the batching. If the weight comes back below to the minimum set, the batching starts.
- COhSP:** it is displayed when at the batching start the APPROVAL input is open (if the input 3 is set as approval; In 3 = **COhS**). Close the input to enable batching or cancel it by pressing **ESC**.
- hDL:** it is displayed if at batching end the weight is different from the value set in formula by a value higher than tolerance. Press **ENTER** to cancel the alarm and continue with the batching.
- FALL:** it is displayed if at batching start the fall value is higher than the product quantity to be batched. Press **ESC** to cancel the alarm and the batching.
- ENPEY:** it is displayed if, at batching start, the formula recalled for running is not programmed. Press the key **ESC** to quit.
- hASFOr:** it is displayed if, at batching start, the formula recalled for running exceeds the maximum weight. Press the key **ESC** to quit.
- PAUSE:** it means that during batching the **STOP** key has been pressed, temporarily interrupting the cycle; press the **ENTER** key to start it again, or **STOP** to terminate completely the batching.
- hLACH:** it indicates that a power failure occurred during batching; press **ESC** to cancel the batching or press **ENTER** to resume batching again from the point of interruption.
- LOAD:** during the batching it indicates that the product is not loaded. It is automatically cancelled if the product increases. Press **STOP** twice to cancel the batching.
- UnLOAD:** during the unload (Cycle End contact closed) it indicates that the product is not extracted. It is automatically cancelled if the product decreases. Press **STOP** twice to cancel the unload.
- StArEP:** it is displayed for 3 seconds if you try to stop the batching (by pressing twice **STOP** or closing the related input) when the START input is closed. Open the START input to cancel the alarm.
- PARSER:** batching is cancelled. Press **ESC** to quit. If the alarm persists, contact technical assistance.
- ErUEI G:** it is displayed when there is a weight alarm and it cancels the current batching. Press **ESC** to go back to the weight display and check the alarm.
- ErCEL:** the load cell is not connected or is incorrectly connected; the load cell signal exceeds 39 mV; the conversion electronics (AD converter) is malfunctioning; the load cell is a 4-wire and there are no jumpers between EX- and REF- and between EX+ and REF+.
- Er DL:** the weight display exceeds 110% of the full scale.
- Er Ad:** internal instrument converter failure; check load cell connections, if necessary contact technical assistance.
- :** the weight exceeds the maximum weight by 9 divisions.
- Er DF:** maximum displayable value exceeded (value higher than 999999 or lower than -999999).
- h-----:** weight too high: zero setting not possible.

PAH-PU: this message appears in the sample weight setting, in real calibration, after the fifth sample weight value has been entered.

Error: the value set for the parameter is beyond the permitted values; press **[ESC]** to quit the setting mode leaving the previous value unchanged. Examples: a number of decimals is selected for full scale which exceeds the instrument's display potential; value above the maximum setting value; the weight value set in sample weight verification does not match the detected mV increase; the analog output correction goes beyond the permitted limits.

LOC: lock active on menu item, keypad or display.

nDi SP: It's not possible to display properly the number because is greater than 999999 or less than -999999.

bAtE: buffer battery low, loss of date and time of Real-Time Clock. Confirm with **[ENTER]** to continue; leave the instrument on for at least 12 hours to charge the battery, if the alarm persists contact technical assistance.

dAtEP: an incorrect date has been detected: go into the related menu to check and correct it.

CONAd: waiting for START closure or **[ENTER]** key pressure to continue the batching.

PC: PC is not connected.

SLALe: PC has not read batching data.

Serial protocol alarms:

	<i>ErCEL</i>	<i>Er OL</i>	<i>Er Ad</i>	-----	<i>Er OF</i>	<i>t-----</i>
MODE						
Bit LSB	76543210 xxxxxxxx1	76543210 xxxx1xxx	76543210 xxxxxxxx1x	76543210 xxxxx1xx	76543210 On gross: xxx1xxxx On net: xx1xxxxx	The instrument's response to the zero command is a 'value not valid' error (error code 3)
Status Register MODBUS RTU						
RIP *	__O-F__	__O-L__	__O-F__	__O-L__	__O-F__	__O-F__
HDRIP-N	_ERCEL	_ER_OL	_ER_AD	#####	_ER_OF	O_SET

* For RIP remote displays, if the message exceeds 5 digits the display reads -----.

With an alarm the relays open and the analog outputs go to the lowest possible value according to the following table:

RANGE	0÷20 mA	4÷20 mA	0÷5 V	0÷10 V	±10 V	±5 V
Output value	-0.2 mA	3.5 mA	-0.5 V	-0.5 V	0 V	0 V

PRINTING EXAMPLES

If the printer has been set (see section **SERIAL COMMUNICATION SETTING**), from the weight display press the **PRINT** key for less than 3 seconds:

- **WEIGHT**: prints the displayed weight;
- **CONST**: prints the constants (minimum weight, maximum weight, etc.);
- **FORM**: prints one or all of the formulas; press **ENTER** to display **FORM 1**, set the formula number to be printed or "00" to print them all;
- **TOTAL**: prints consumption (only if **TOTAL** = **YES**, see **CONSUMPTION FOR EACH FORMULA**).

BATCHING PRINTOUT

Batching without tare (**ALARE** = 0)

```
-----
W---  LOAD      Addr:01
FORMULA:                01
CYCLE:      1/      1
DATE: 01/10/11 08:30:01
```

```
INIT.WEIGHT      10 kg
GROSS  1005:     1000 kg
```

Batching with tare each cycle (**ALARE** = 1)

```
-----
W---  LOAD      Addr:01
FORMULA:                01
CYCLE:      1/      1
DATE: 01/10/11 08:30:01
```

```
TARE                34 kg
NET  1005:     1000 kg
```

Batching with reset every X cycles (**ALARE** = X)

```
-----
W---  LOAD      Addr:01
FORMULA:                01
CYCLE:      2/      2
DATE: 01/10/11 08:30:01
```

```
INIT.WEIGHT      1 kg
GROSS  1070:     1000 kg
```

```
-----
W---  LOAD      Addr:01
FORMULA:                01
CYCLE:      1/      2
DATE: 01/10/11 08:30:01
```

```
ZERO WEIGHT      12 kg
GROSS  1026:     1000 kg
```

CONSTANTS PRINTOUT

```
-----  
W---   LOAD      Addr:01  
DATE: 01/10/11 08:30:01  
      CONSTANTS  
MIN                10  
MASS               0  
TIME SIC           5.0  
TIME WAIT          0.0  
TIME NCOMP         0.0  
TIME NLOAD         0.0  
TIME NUNLOAD       0.0  
FALL              MANUAL  
SLOW              0  
TIME SLOWON        0.0  
TIME SLOWOF        0.0  
PSS               2  
AUTOTARE          NO  
UNLOAD            GROSS  
TOTAL             NO  
PRINT             NO  
PC                NO  
SLAVE             NO  
BLACKOUT          MANUAL  
RELAY ALARM       0  
RELAY TOL.        0
```

```
FOR.      FALL      TOLER  
05         0         100  
48        178        0
```

FORMULA PRINTOUT

Standard formula printout (**SLOW** = 0)

```
-----  
W---   LOAD      Addr:01  
DATE: 01/10/11 08:30:01  
FORMULA:          02  
SET              2000 kg  
PSET             200 kg
```

Formula with slow active printout (**SLOW** = 100)

```
-----  
W---   LOAD      Addr:01  
DATE: 01/10/11 08:30:01  
FORMULA:          02  
SET              2000 kg  
SLOW             100 kg
```

CONSUMPTION PRINTOUT

W--- LOAD Addr:01
DATE: 01/10/11 08:30:38
CONSUMPTION
F01 1148 kg
F03 1456 kg
TOTAL 2604 kg
FROM: 01/09/11 09:11:13

If consumption is set to zero, it will also be printed:
CONSUMPTION ERASED

WEIGHT PRINTOUT







Basic printout

W--- LOAD Addr:01
DATE: 12/09/11 14:48:12



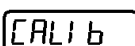

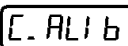
GROSS 1204 kg
NET 831 kg
TARE 373 kg

MENU LOCKING



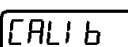

Through this procedure, it's possible to block the access to any menu on the instrument. Select the menu that you wish to lock:

   press  and  simultaneously for 3 seconds, the display shows  (the left point on the text indicates that this menu item is now locked). If the operator tries to enter this menu, the access is denied and the display shows .

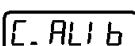

MENU UNLOCKING

   press  and  simultaneously for 3 seconds, the display shows  (the left point on the text is off to indicate that this menu item is unlocked).

TEMPORARY MENU UNLOCKING

   press  and  simultaneously for 3 seconds: it is now possible to enter and modify all menus including those which are locked. By returning to weight display, the menu lock is restored.

DATA DELETION AND PROGRAM SELECTION

WARNING: operations must only be performed after contacting technical assistance. After each operation the display shows *dOnE*, press  to continue. By pressing  the procedure is cancelled and no changes are made.

Upon instrument power-on hold down the  key until the display shows *PrOG*, then proceed as follows:

CONSTANTS RESTORE (does not erase the calibration): confirm *PrOG*, use arrow keys to select *PASSU*, set code 6935 and confirm.

PROGRAM SELECTION: confirm **PrOG** and use the arrow keys to select the desired program:

bASE: basic program, setpoint management only.

rEuEr: to be used when the loaded weighing system correspond to not loaded cells and vice versa (product increases while weight on load cells actually decreases).

r iP: weight remote display program with setpoint.

LOAD: monoprodukt loading program.

UnLOAD: monoprodukt unloading program.

3PrOd: 3 products batching.

6PrOd: 6 products batching.

14PrOd: 14 product batching.

NULL: no program.

After confirming the choice of the program (except **rEuEr** and **r iP**), the user must choose its approval state among the following possible choices:



nOLEG: not approved program;

LEGAL: approved program, single division (Dir. 2009/23/EC, art. 1)*;

LEGN: approved program, multi-interval (Dir. 2009/23/EC, art. 1)*;

LEGNr: approved program, multiple range (Dir. 2009/23/EC, art. 1)*;

- *) Contact technical assistance to request the proper manual and the correct procedures for approval, indicating mandatory hardware code and serial number (see section **INSTRUMENT COMMISSIONING**).

By confirming, the instrument is restored to default and data is erased.



If you do not have a specific manual for the newly set program, you can request it to technical assistance.

KEYPAD OR DISPLAY LOCKING

Press **ESC** immediately followed by **▲** hold them down for about 5 seconds (this operation is also possible via the MODBUS and ASCII protocols):

- **FrEE:** no lock.
- **HEy:** keypad lock: if active, when a key is pressed the message **bLOC** is displayed for 3 seconds.
- **di SP:** keypad and display lock: if active, the keypad is locked and the display shows the instrument model (weight is not displayed); by pressing a key the display shows **bLOC** for 3 seconds.

DECLARATION OF CONFORMITY

LAUMAS[®]
ELETTRONICA

SISTEMI DI PESATURA INDUSTRIALE - CELLE DI CARICO



Sistema di gestione
Qualità certificato
UNI EN ISO 9001:2008



CERTIFICAZIONE DEL SISTEMA DI GARANZIA DELLA QUALITÀ DELLA PRODUZIONE

LAUMAS Elettronica S.r.l.
Tel. (+39) 0521 683124 - Fax (+39) 0521 681091
Via 1° Maggio 6 – 43022 Montechiarugolo (PR) Italy
C.F. - P.IVA IT01661140341

email: laumas@laumas.it

web: <http://www.laumas.com>





Fabbricante metrico Prot. N. 7340 Parma - R.E.A. PR N. 169833 - Reg. Imprese
PR N.19393 - Registro Nazionale Pile N° IT09060P00000982 - Registro A.E.E.
N° IT08020000002494 - N. Mecc. PR 008385 - Cap. Soc. Euro 10.400 int. vers.

EC-Konformitätserklärung
EC- Déclaration de conformité
EC-Dichiarazione di conformità
EC- Declaração de conformidade
EC-Deklaracja zgodności

EC-Declaration of Conformity
EC-Declaración de Conformidad
EC-Conformiteitverklaring
EC- Prohlášení o shode
EC-Заявление о соответствии

I	Dichiarazione di conformità	Dichiariamo che il prodotto al quale la presente dichiarazione si riferisce è conforme alle norme di seguito citate.
GB	Declaration of conformity	We hereby declare that the product to which this declaration refers conforms with the following standards.
E	Declaración de conformidad	Manifestamos en la presente que el producto al que se refiere esta declaración está de acuerdo con las siguientes normas
D	Konformitäts-erklärung	Wir erklären hiermit, dass das Produkt, auf das sich diese Erklärung bezieht, mit den nachstehenden Normen übereinstimmt.
F	Déclaration de conformité	Nous déclarons avec cela responsabilité que le produit, auquel se rapporte la présente déclaration, est conforme aux normes citées ci-après.
CZ	Prohlášení o shode	Tímto prohlašujeme, že výrobek, kterého se toto prohlášení týká, je v souladu s níže uvedenými normami.
NL	Conformiteit-verklaring	Wij verklaren hiermede dat het product, waarop deze verklaring betrekking heeft, met de hierna vermelde normen overeenstemt.
P	Declaração de conformidade	Declaramos por meio da presente que o produto no qual se refere esta declaração, corresponde às normas seguintes.
PL	Deklaracja zgodności	Niniejszym oświadczamy, że produkt, którego niniejsze oświadczenie dotyczy, jest zgodny z poniższymi normami.
RUS	Заявление о соответствии	Мы заявляем, что продукт, к которому относится данная декларация, соответствует перечисленным ниже нормам.

Models: WDESKL, WDESKR, WINOXL, WINOX2L, WINOXR, WTABL, WTABR

Mark Applied	EU Directive	Standards
	2006/95/EC Low Voltage Directive	<i>Not Applicable (N/A)</i> for VDC type EN 61010-1 for 230/115 VAC type
	2004/108/EC EMC Directive	EN 55022 EN 61000-6-2 EN 61000-6-4 EN 61000-4-2/3/4/5/6
  (only if "M" mark is applied)	2009/23/EC NAWI Directive	EN 45501:1992 OIML R76-1:2006

Montechiarugolo (PR), 08/10/2013

LAUMAS Elettronica s.r.l.
M. Consonni (**RCQ**)

